

**STRATA PLAN OF LOT 1
EXCEPT PART SUBDIVIDED BY
AIRSPACE PLAN EPP23681
BLOCK 2 DISTRICT LOT 302 GROUP 1
NEW WESTMINSTER DISTRICT
PLAN BCP36925**

CITY OF VANCOUVER
BCGS 92G.025



SCALE 1 : 500 DISTANCES ARE IN METRES

THE INTENDED PLOT SCALE OF THIS PLAN IS 280 mm IN WIDTH BY 432 mm IN HEIGHT (B SIZE) WHEN PLOTTED AT A SCALE OF 1:500.

INTEGRATED SURVEY AREA No. 31 (VANCOUVER)
NAD83 (CSRS)

THIS PLAN SHOWS HORIZONTAL GROUND-LEVEL DISTANCES EXCEPT WHERE OTHERWISE NOTED. TO COMPLETE GRID DISTANCES, MULTIPLY GROUND-LEVEL DISTANCES BY COMBINED FACTOR, 0.99980315.

NOTE: THIS PLAN SHOWS ONE OR MORE WITNESS POSTS WHICH ARE NOT SET ON THE TRUE CORNER(S).



STRATA PLAN EPS984

**'THE MAYNARDS
BLOCK'**

CIVIC ADDRESS:

1919 WYLIE STREET
VANCOUVER, B.C.

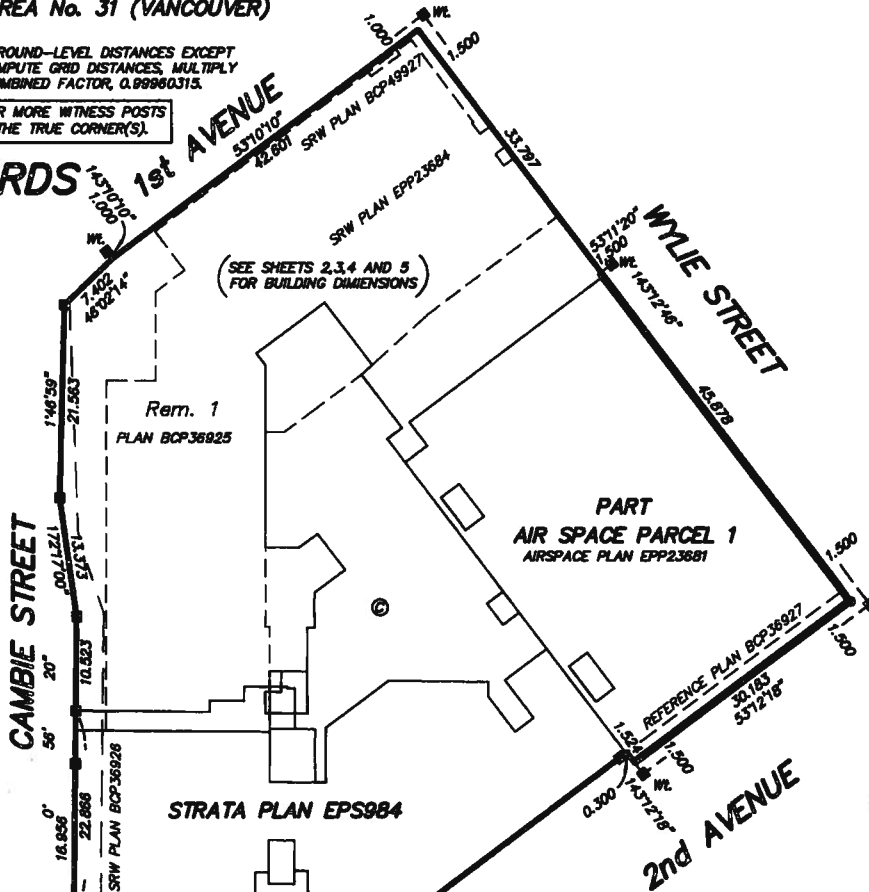

THE BUILDINGS SHOWN HEREON ARE WITHIN THE EXTERNAL BOUNDARIES OF THE LAND THAT IS THE SUBJECT OF THE STRATA PLAN

THE BUILDINGS INCLUDED IN THIS STRATA PLAN HAVE NOT BEEN PREVIOUSLY OCCUPIED

NOTE:

NOTICE UNDER SECTION 69 OF THE STRATA PROPERTY ACT. STRATA LOT BOUNDARIES ARE DEFINED AS THE EXTERIOR FACE OF EXTERIOR WALLS, THE EXTERIOR FACE OF INTERIOR WALLS ADJOINING COMMON AREAS AND THE CENTRE LINE OF DEMISING WALLS BETWEEN STRATA LOTS.
THIS PLAN CONTAINS LIMITED COMMON PROPERTY UNDER SECTION 73 (a)(1) OF THE STRATA PROPERTY ACT.

THE FIELD SURVEY REPRESENTED BY THIS PLAN WAS COMPLETED BY GARY SUNDWICK, BCLS (837) ON THE 31st DAY OF AUGUST, 2012.
ECR#140353

LEGEND:

- GRID BEARINGS ARE DERIVED FROM PLAN BCP36925
- | | | |
|-------|--------|--|
| FOUND | PLACED | DENOTES LEAD PLUG |
| ● | □ | DENOTES IRON POST |
| ○ | | |
| SL | | DENOTES STRATA LOT |
| PT. | | DENOTES PART |
| Ⓢ | | DENOTES COMMON PROPERTY |
| Ⓜ | | DENOTES MECHANICAL - COMMON PROPERTY |
| ⓔ | | DENOTES ELECTRICAL - COMMON PROPERTY |
| Ⓥ | | DENOTES VESTIBULE - COMMON PROPERTY |
| Ⓟ | | DENOTES PLANTER - COMMON PROPERTY |
| Ⓢ | | DENOTES BALCONY BEING LIMITED COMMON PROPERTY FOR EXCLUSIVE USE OF ADJOINING STRATA LOT |
| Ⓢ-1 | | DENOTES PATIO BEING LIMITED COMMON PROPERTY FOR EXCLUSIVE USE OF STRATA LOT 1 (TYPICAL) |
| Ⓢ-39 | | DENOTES BALCONY BEING LIMITED COMMON PROPERTY FOR EXCLUSIVE USE OF STRATA LOT 39 (TYPICAL) |
| Ⓢ-20 | | DENOTES DECK BEING LIMITED COMMON PROPERTY FOR EXCLUSIVE USE OF STRATA LOT 20 (TYPICAL) |
| Ⓢ11 | | DENOTES COORDINATE POINT 111 FOR AIRSPACE PARCEL 1 AIRSPACE PLAN EPP23681 (TYPICAL) |

THIS PLAN LIES WITHIN THE GREATER VANCOUVER REGIONAL DISTRICT



4 - 19089 84th Ave
Surrey, BC V4N 3S4
www.butlersundwick.com
Tel. 604-513-9811

File: 3688/STRATA/FINAL STRATA
Dwg: 3688-STRATA

BUILDING LOCATION

STRATA PLAN EPS984

0 5 10 15

SCALE 1:200 DISTANCES ARE IN METRES

THE INTENDED PLOT SCALE OF THIS PLAN IS 280 mm IN WIDTH BY 432 mm IN HEIGHT (B SIZE) WHEN PLOTTED AT A SCALE OF 1:200.

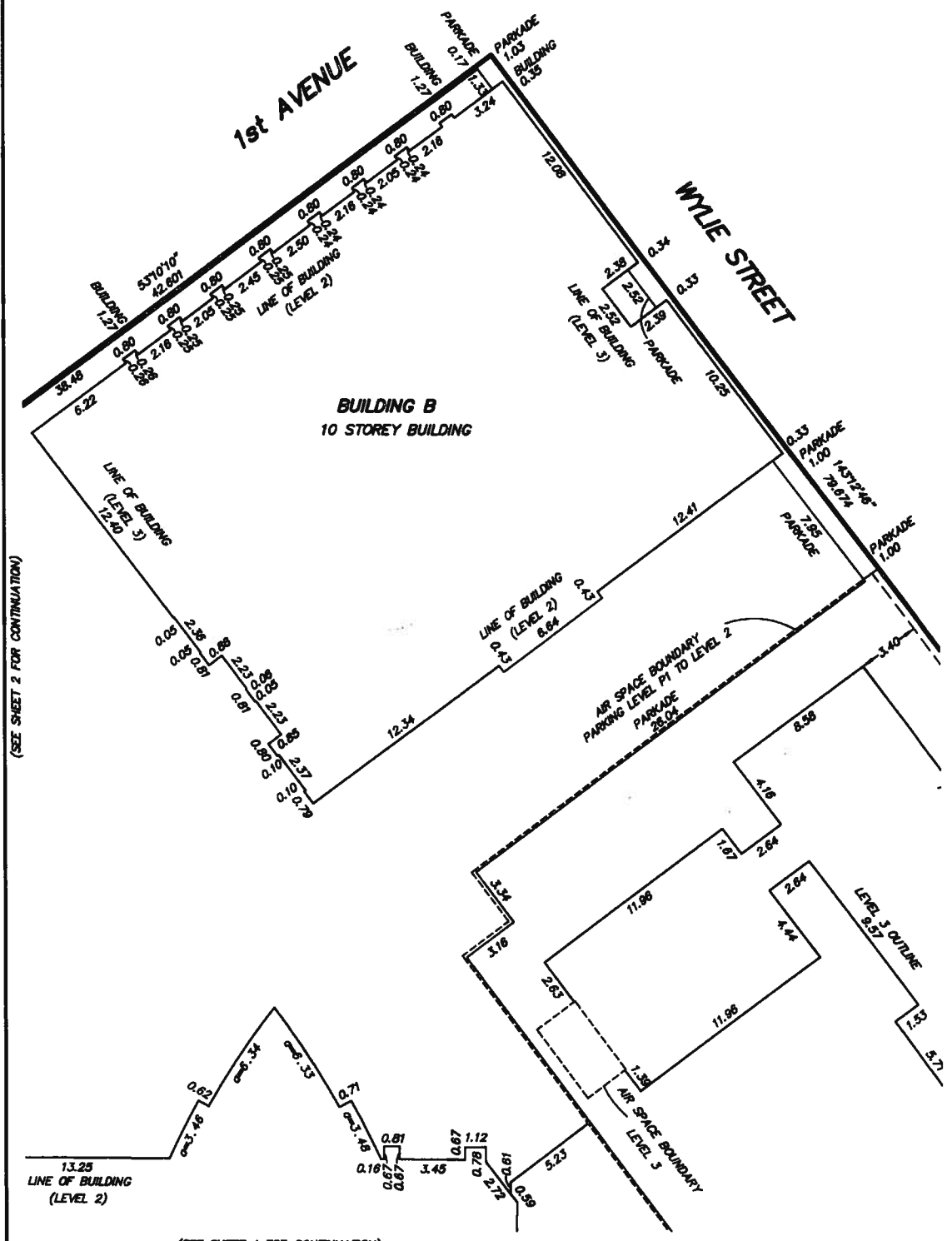

(SEE SHEET 2 FOR CONTINUATION)

(SEE SHEET 4 FOR CONTINUATION)

BUTLER SUNDVICK
GARY SUNDVICK, BCLS
Date: SEPTEMBER 7, 2012
File: 3686\Strata-Final
Dwg: 3686-Strata

BUILDING LOCATION

STRATA PLAN EPS984

0 5 10 15
SCALE 1:200 DISTANCES ARE IN METRES
THE INTENDED PLOT SCALE OF THIS PLAN IS 280 mm IN WIDTH BY 432 mm IN HEIGHT (B SIZE) WHEN PLOTTED AT A SCALE OF 1:200.



(SEE SHEET 2 FOR CONTINUATION)

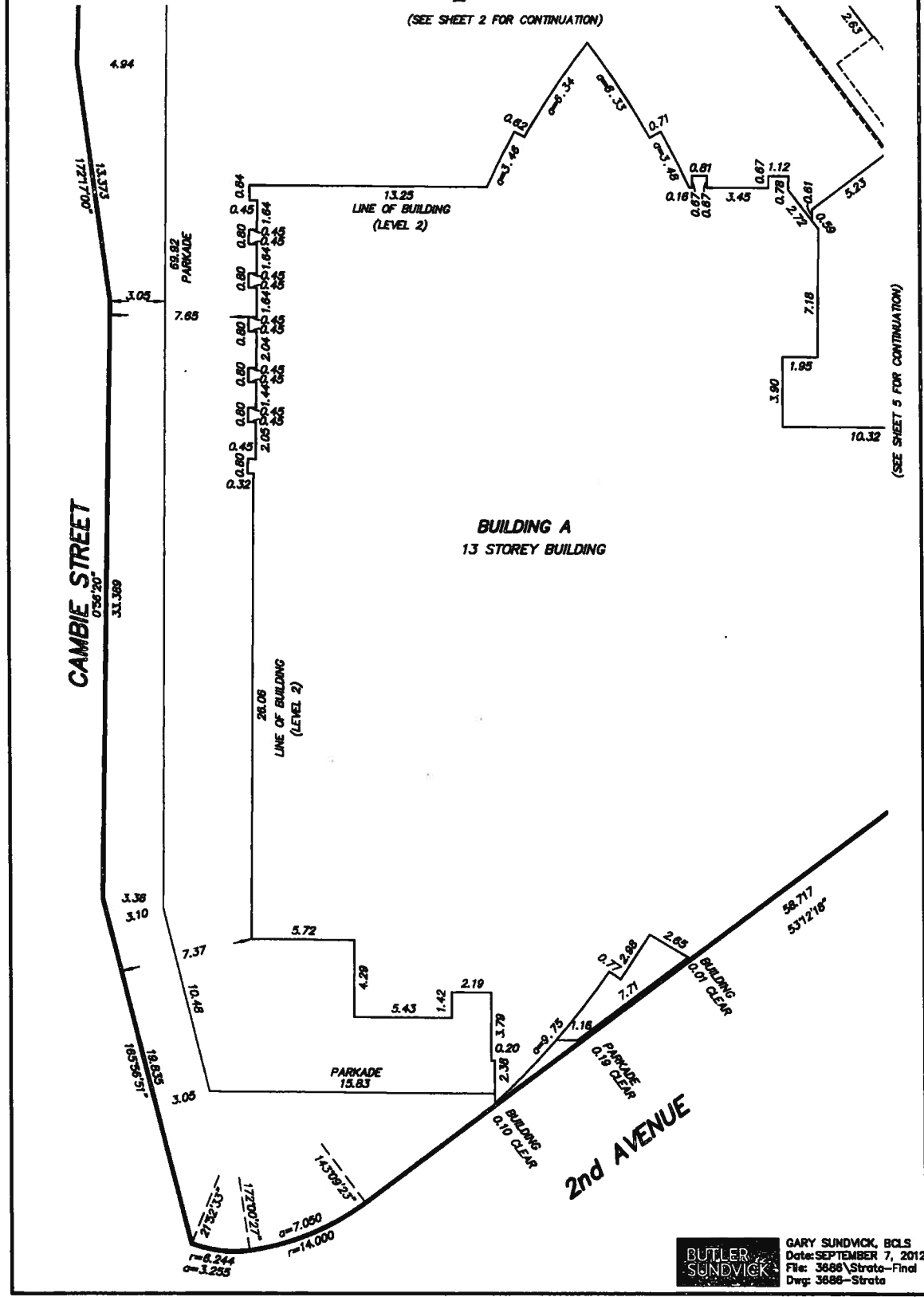

(SEE SHEET 5 FOR CONTINUATION)



GARY SUNDVICK, BCLS
Date: SEPTEMBER 7, 2012
File: 3888\Strata-Final
Dwg: 3888-Strata

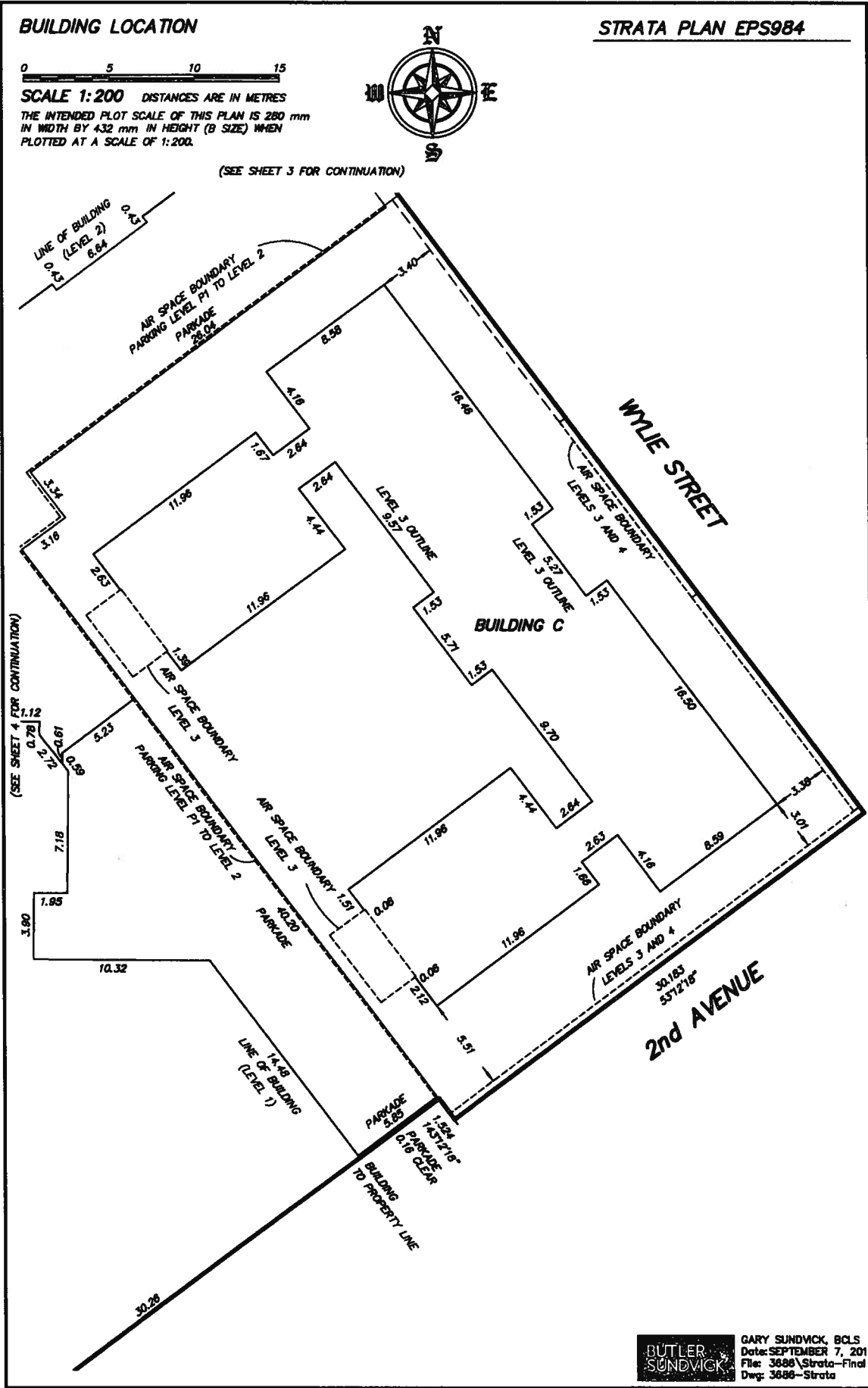

BUTLER SUNDVICK
 GARY SUNDVICK, B.C.L.S.
 Date: SEPTEMBER 7, 2012
 File: 3688-Strata-Final
 Dwg: 3688-Strata

FLOOR PLAN
PARKING LEVEL P4

STRATA PLAN EPS984



SCALE 1:200 DISTANCES ARE IN METRES
THE INTENDED PLOT SCALE OF THIS PLAN IS 280 mm
IN WIDTH BY 432 mm IN HEIGHT (B SIZE) WHEN
PLOTTED AT A SCALE OF 1:200.

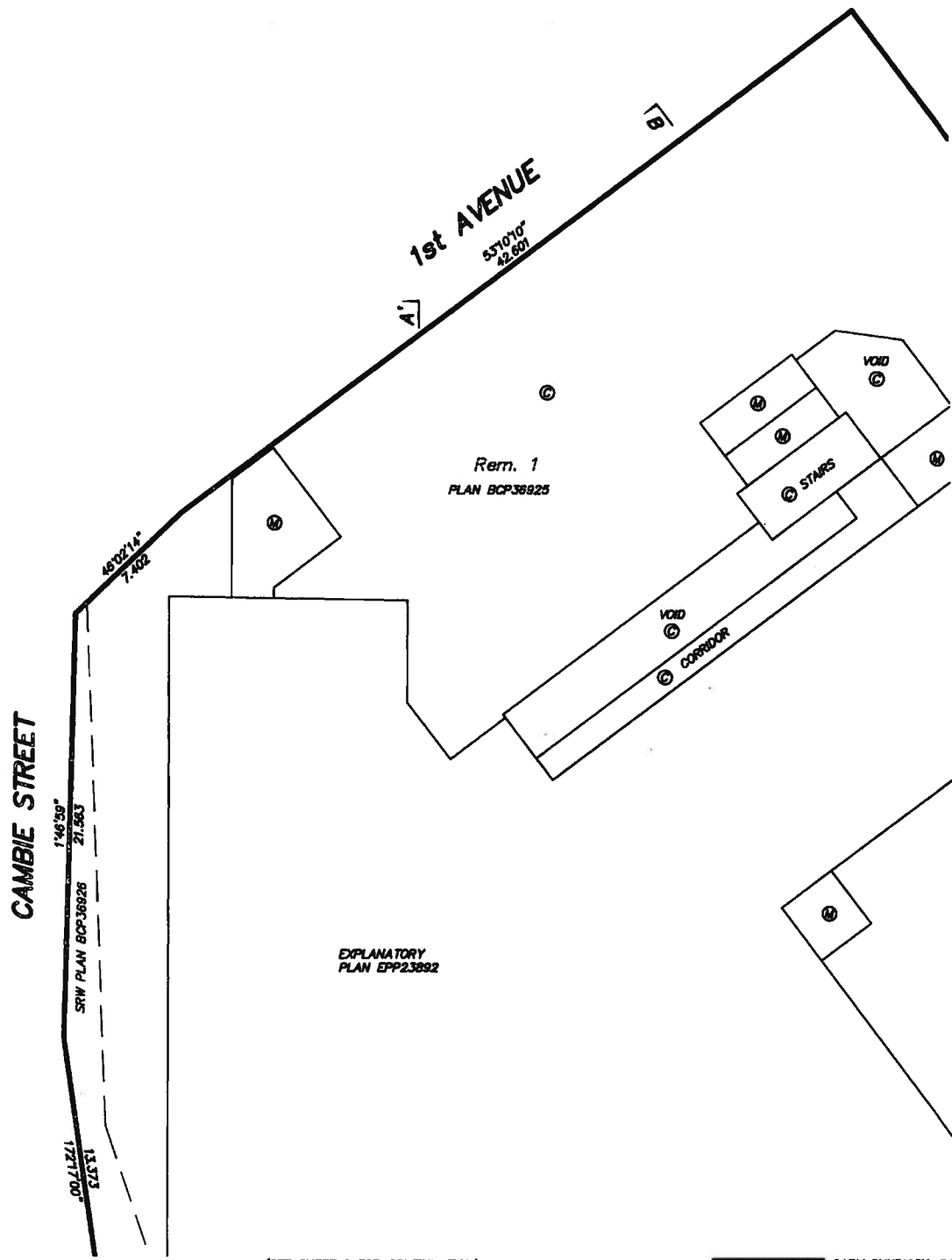

Rem. 1
PLAN BCP38825

EXPLANATORY
PLAN EPP23892

(SEE SHEET 7 FOR CONTINUATION)

(SEE SHEET 8 FOR CONTINUATION)



GARY SUNDVICK, BCLS
Date: SEPTEMBER 7, 2012
File: 3888\Strata-Final
Dwg: 3888-Strata

**FLOOR PLAN
PARKING LEVEL P4**



SCALE 1:200 DISTANCES ARE IN METRES

THE INTENDED PLOT SCALE OF THIS PLAN IS 280 mm IN WIDTH BY 432 mm IN HEIGHT (B SIZE) WHEN PLOTTED AT A SCALE OF 1:200.



STRATA PLAN EPS984

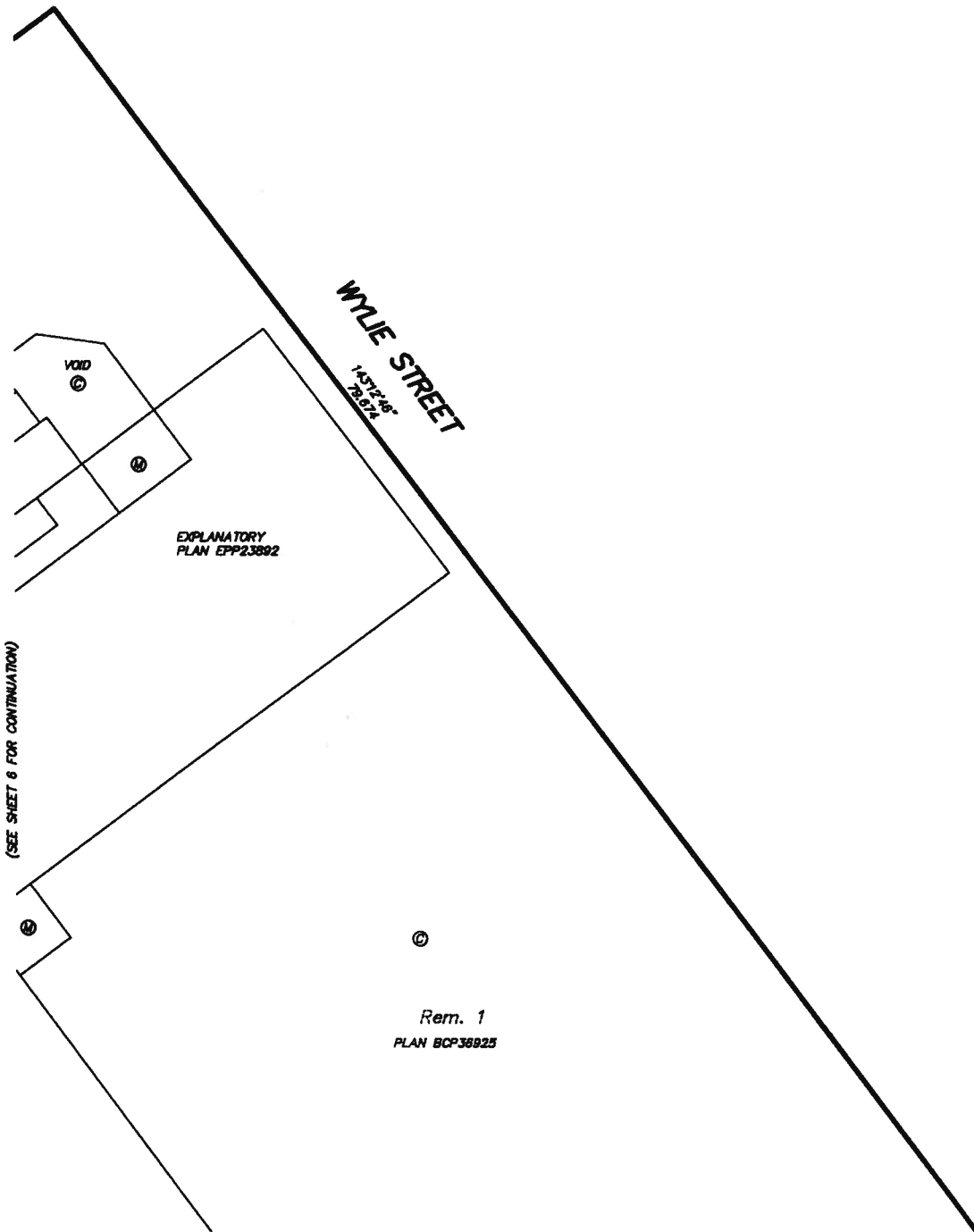

(SEE SHEET 6 FOR CONTINUATION)

(SEE SHEET 9 FOR CONTINUATION)

**BUTLER
SUNDVICK**
 GARY SUNDVICK, BCLS
 Date: SEPTEMBER 7, 2012
 File: 3888\Strata-Final
 Dwg: 3888-Strata

FLOOR PLAN
PARKING LEVEL P4

STRATA PLAN EPS984

0 5 10 15

SCALE 1:200 DISTANCES ARE IN METRES
THE INTENDED PLOT SCALE OF THIS PLAN IS 280 mm
IN WIDTH BY 432 mm IN HEIGHT (B SIZE) WHEN
PLOTTED AT A SCALE OF 1:200.



(SEE SHEET 6 FOR CONTINUATION)

(SEE SHEET 9 FOR CONTINUATION)

CAMBIE STREET

2nd AVENUE

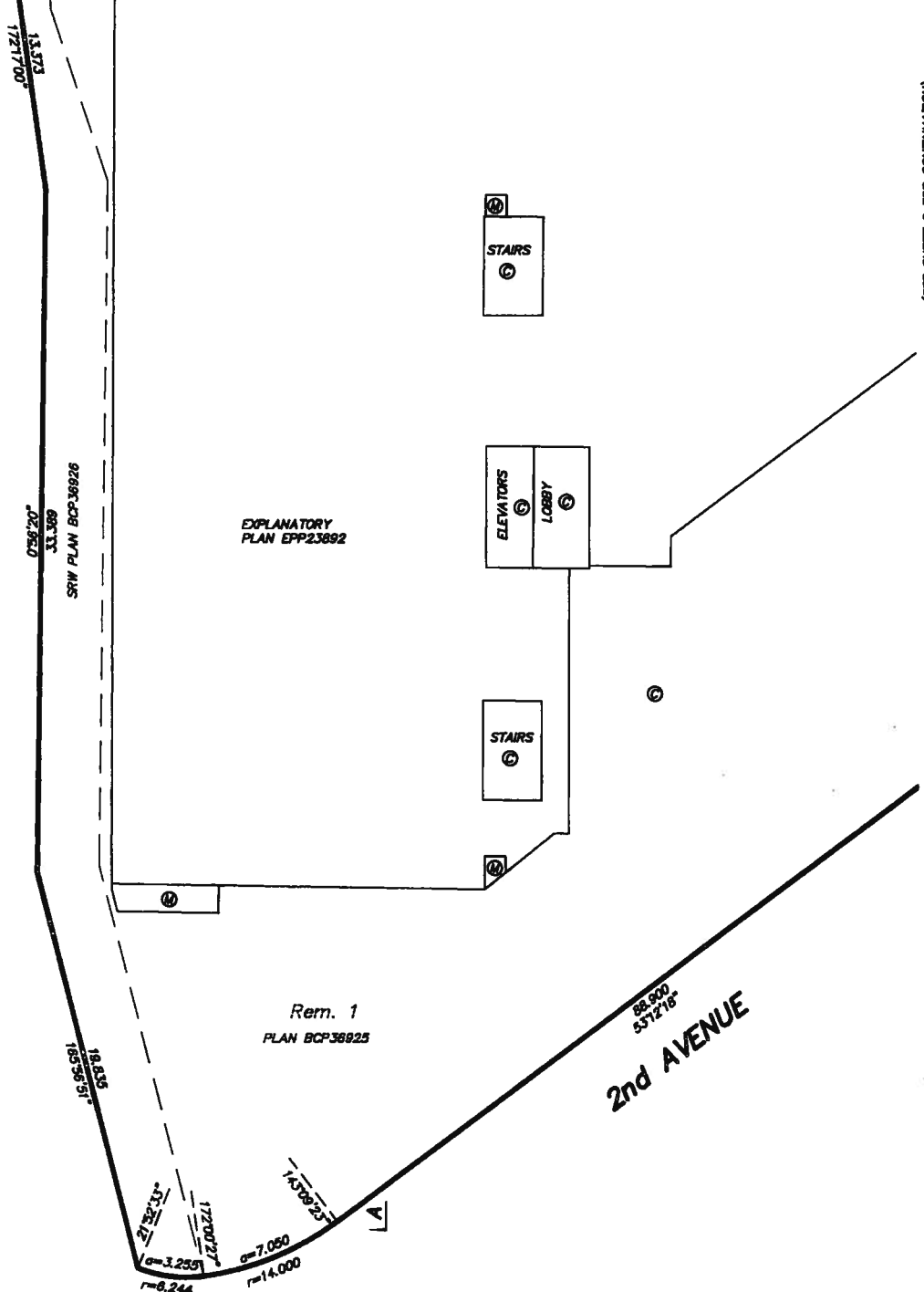

EXPLANATORY
PLAN EPP23892

Rem. 1
PLAN BCP38825

13.373
1727.700

0756'20"
33.389
SRW PLAN BCP38826

16.98591
18.83

27'52"23"
1720'27"
r=6.244
a=3.255

a=7.050
r=14.000

88.900
5312'18"

BUTLER
SUNDEVICK

GARY SUNDEVICK, BCLS
Date: SEPTEMBER 7, 2012
File: 3888\Strata-Final
Dwg: 3888-Strata

FLOOR PLAN
PARKING LEVEL P4

0 5 10 15

SCALE 1:200 DISTANCES ARE IN METRES

THE INTENDED PLOT SCALE OF THIS PLAN IS 280 mm IN WIDTH BY 432 mm IN HEIGHT (B SIZE) WHEN PLOTTED AT A SCALE OF 1:200.



STRATA PLAN EPS984

(SEE SHEET 7 FOR CONTINUATION)

Rem. 1
PLAN BCP38925

(SEE SHEET 8 FOR CONTINUATION)

EXPLANATORY
PLAN EPP23892

EXPLANATORY
PLAN EPP23892

PULL
PIT

2nd AVENUE

WYLE STREET

30.185
5572'18"

14.572'18"
1.324
58.717
5572'18"



GARY SUNDWICK, BCLS
Date: SEPTEMBER 7, 2012
File: 3888\Strata-Final
Dwg: 3888-Strata

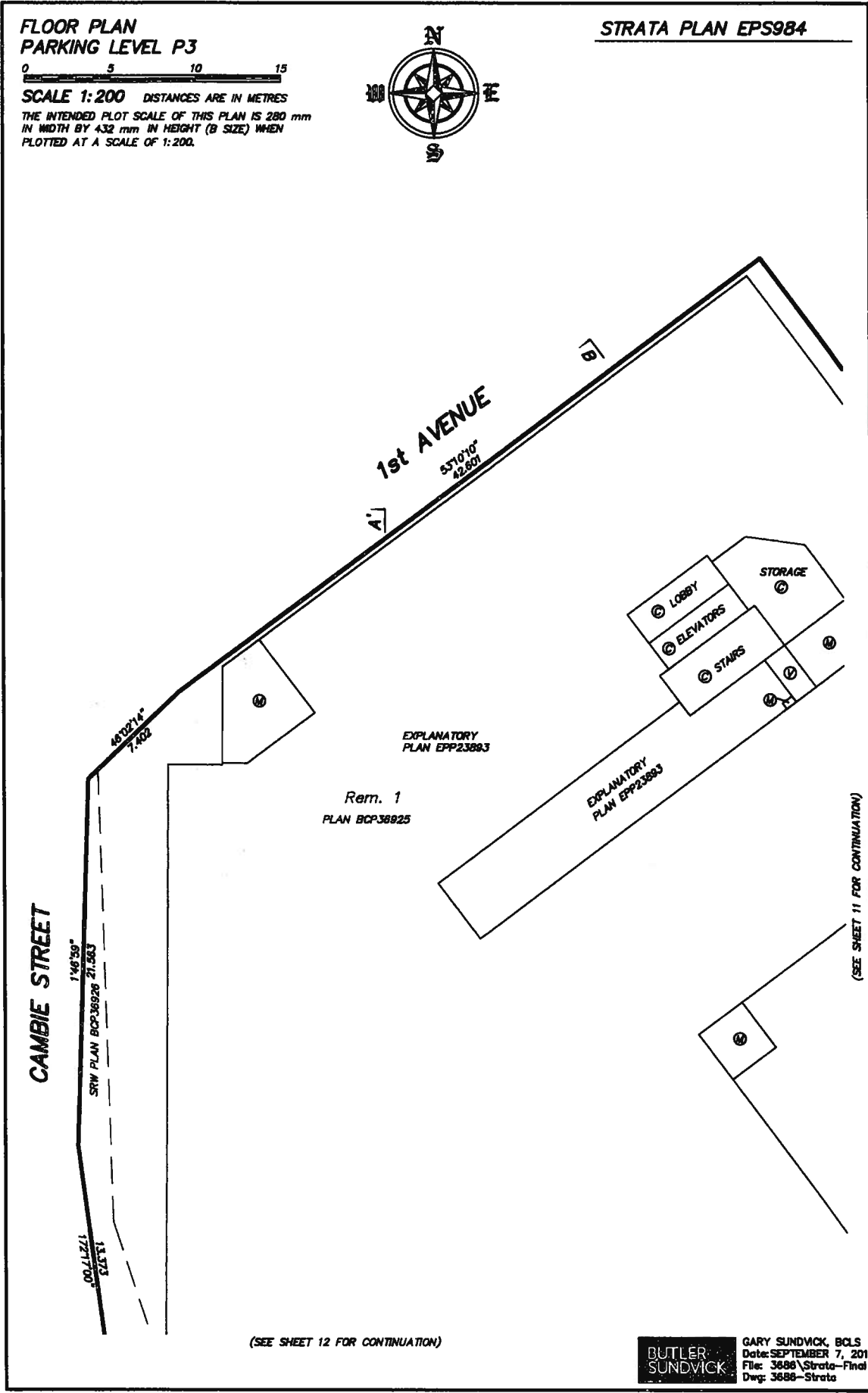

**FLOOR PLAN
PARKING LEVEL P3**

0 5 10 15

SCALE 1:200 DISTANCES ARE IN METRES
THE INTENDED PLOT SCALE OF THIS PLAN IS 280 mm
IN WIDTH BY 432 mm IN HEIGHT (B SIZE) WHEN
PLOTTED AT A SCALE OF 1:200.



STRATA PLAN EPS984

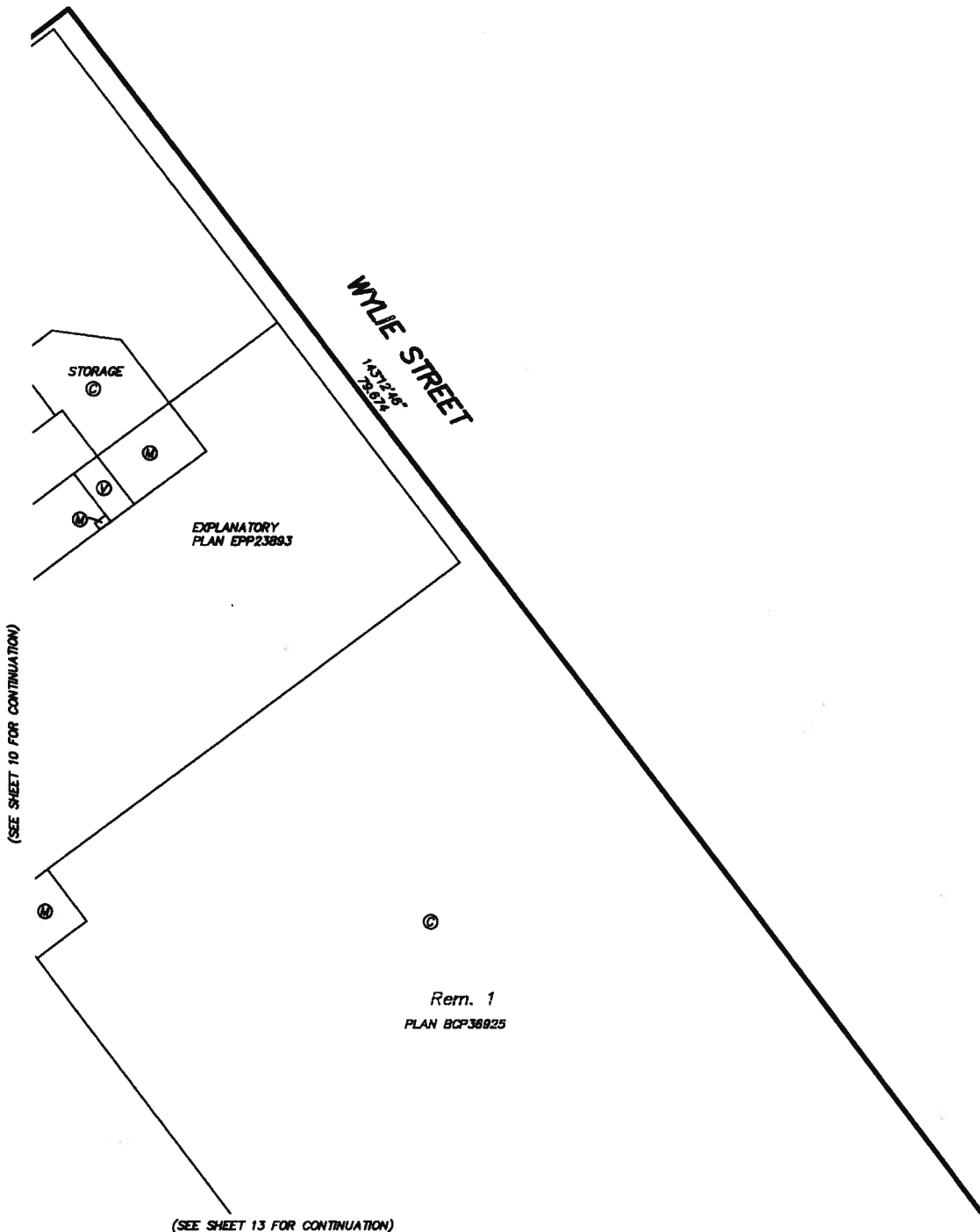

**BUTLER
SUNDVICK**
 GARY SUNDVICK, BCL.S
 Date: SEPTEMBER 7, 2012
 File: 3686\Strata-Final
 Dwg: 3686-Strata

FLOOR PLAN
PARKING LEVEL P3

0 5 10 15

SCALE 1:200 DISTANCES ARE IN METRES
THE INTENDED PLOT SCALE OF THIS PLAN IS 280 mm
IN WIDTH BY 432 mm IN HEIGHT (B SIZE) WHEN
PLOTTED AT A SCALE OF 1:200.



STRATA PLAN EPS984

(SEE SHEET 10 FOR CONTINUATION)

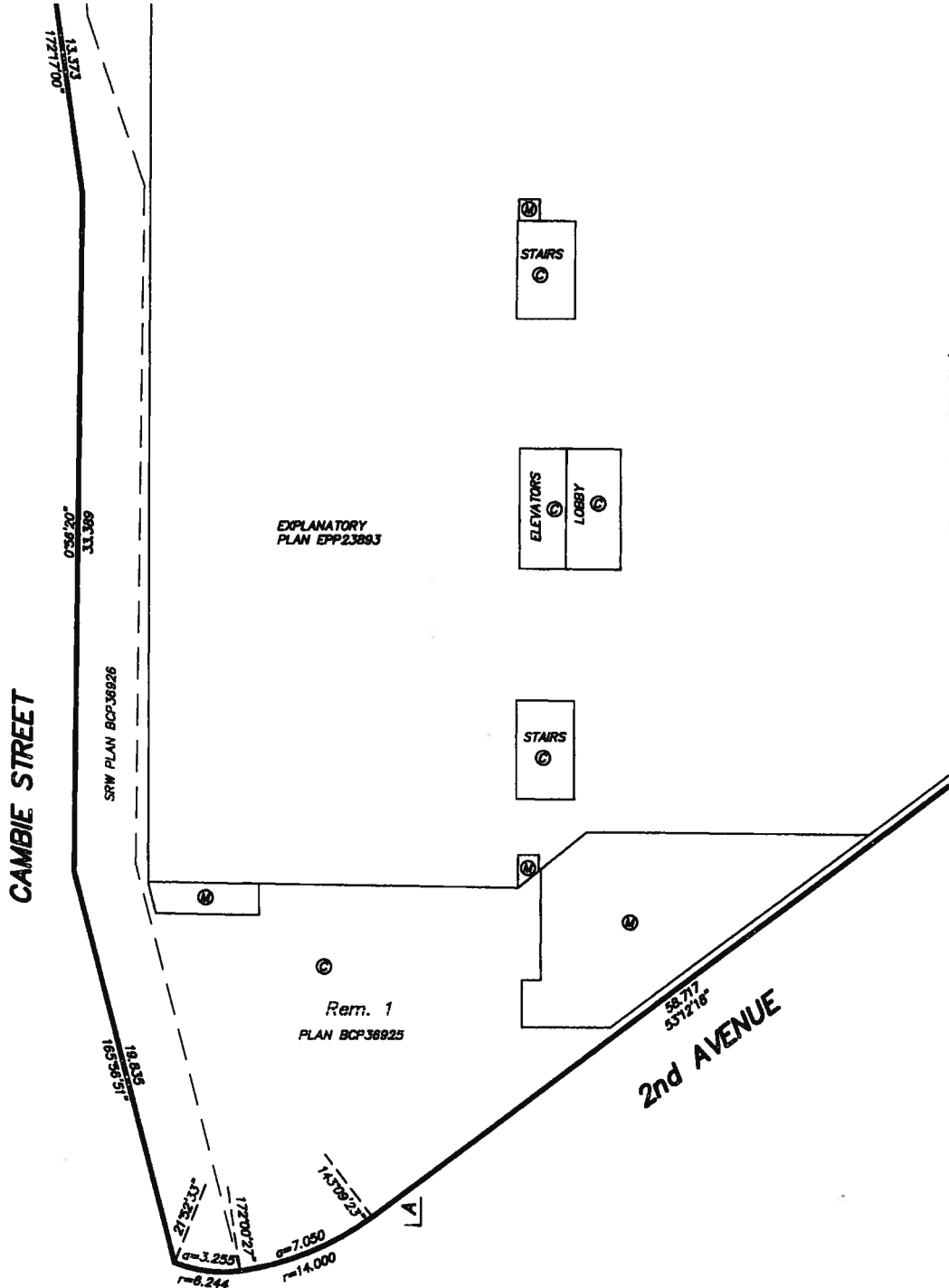

(SEE SHEET 13 FOR CONTINUATION)

BUTLER SUNDVICK
GARY SUNDVICK, BCLS
Date: SEPTEMBER 7, 2012
File: 3688\Strata-Final
Dwg: 3688-Strata

**FLOOR PLAN
PARKING LEVEL P3**

STRATA PLAN EPS984

0 5 10 15

SCALE 1:200 DISTANCES ARE IN METRES

THE INTENDED PLOT SCALE OF THIS PLAN IS 280 mm IN WIDTH BY 432 mm IN HEIGHT (B SIZE) WHEN PLOTTED AT A SCALE OF 1:200.



(SEE SHEET 11 FOR CONTINUATION)

WYLE STREET

Rem. 1
PLAN BCP38825

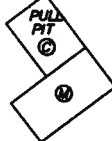

EXPLANATORY
PLAN EPP23883

(SEE SHEET 12 FOR CONTINUATION)

2nd AVENUE



GARY SUNDVICK, BCLS
Date: SEPTEMBER 7, 2012
File: 3688\Strata-Final
Dwg: 3688-Strata

FLOOR PLAN
PARKING LEVEL P2

0 5 10 15

SCALE 1:200 DISTANCES ARE IN METRES
THE INTENDED PLOT SCALE OF THIS PLAN IS 280 mm
IN WIDTH BY 432 mm IN HEIGHT (B SIZE) WHEN
PLOTTED AT A SCALE OF 1:200.



STRATA PLAN EPS984

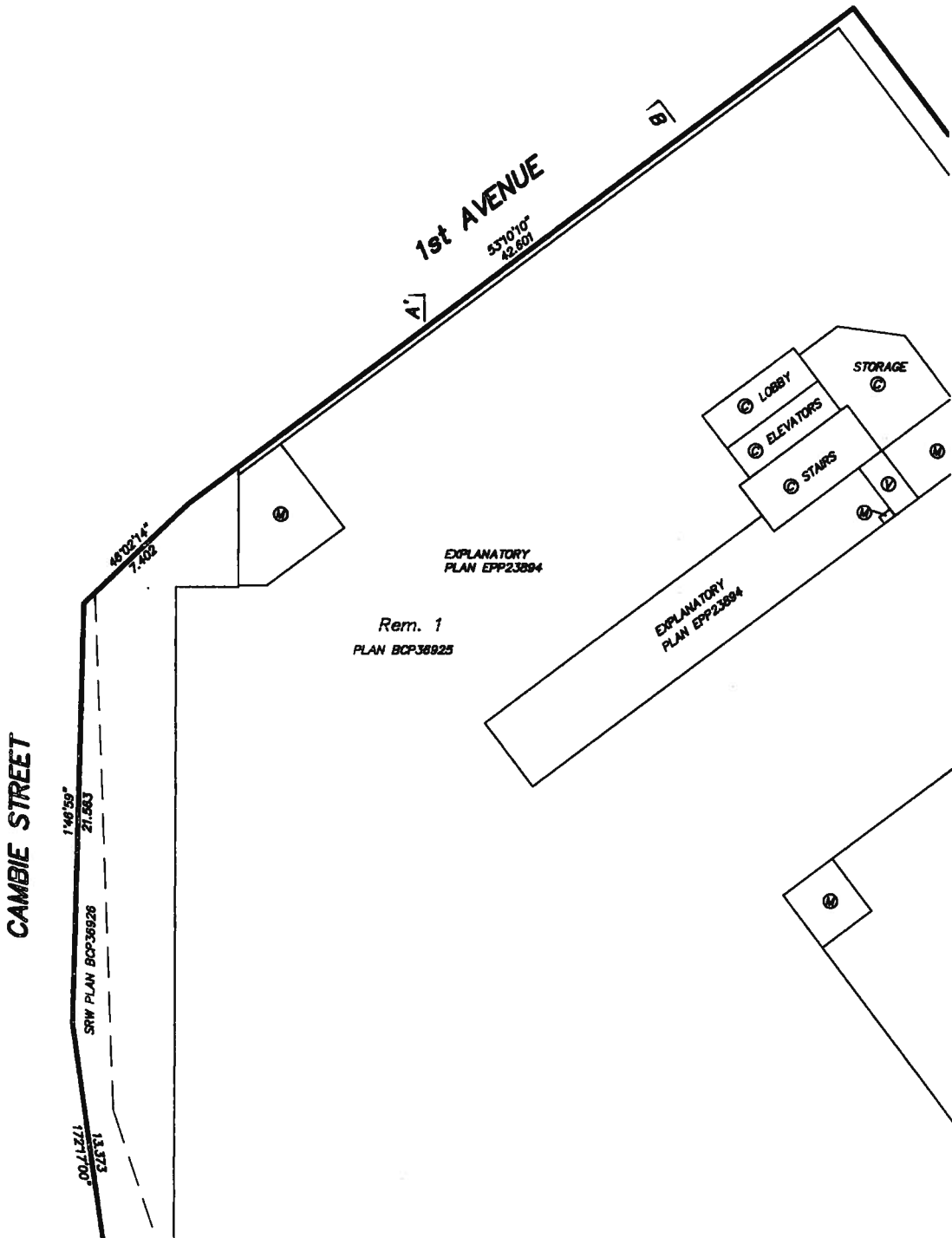

Rem. 1
PLAN BCP36925

EXPLANATORY
PLAN EPP23894

EXPLANATORY
PLAN EPP23894

(SEE SHEET 15 FOR CONTINUATION)

(SEE SHEET 16 FOR CONTINUATION)



GARY SUNDVICK, BCLS
Date: SEPTEMBER 7, 2012
File: 3686\Strata-Final
Dwg: 3686-Strata

**FLOOR PLAN
PARKING LEVEL P2**

STRATA PLAN EPS984

0 5 10 15

SCALE 1:200 DISTANCES ARE IN METRES

THE INTENDED PLOT SCALE OF THIS PLAN IS 280 mm IN WIDTH BY 432 mm IN HEIGHT (B SIZE) WHEN PLOTTED AT A SCALE OF 1:200.

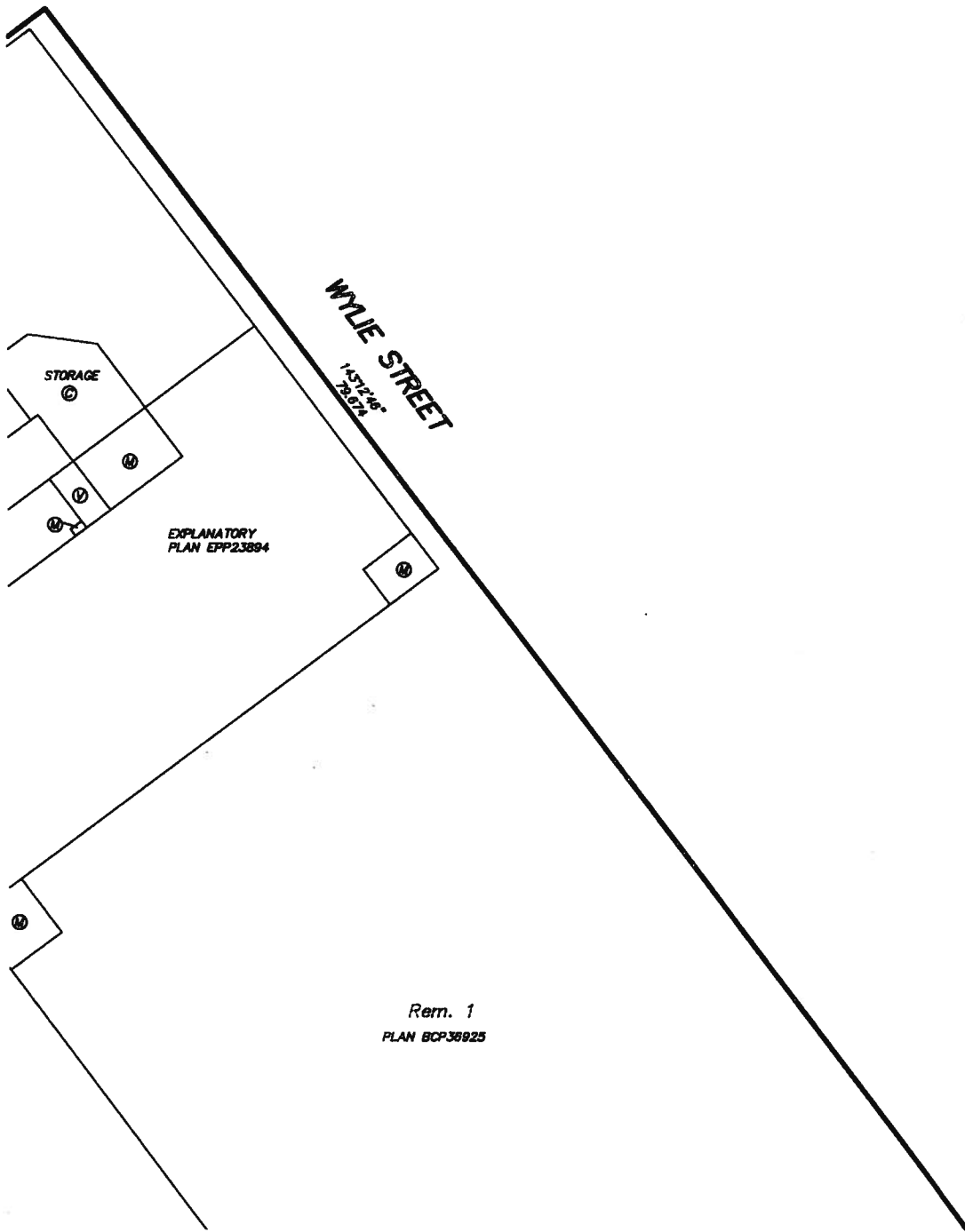

(SEE SHEET 14 FOR CONTINUATION)

Rem. 1
PLAN BCP36925

(SEE SHEET 17 FOR CONTINUATION)



GARY SUNDVICK, BCLS
Date: SEPTEMBER 7, 2012
File: 3688\Strata-Final
Dwg: 3688-Strata

FLOOR PLAN
PARKING LEVEL P2



SCALE 1:200 DISTANCES ARE IN METRES
THE INTENDED PLOT SCALE OF THIS PLAN IS 280 mm
IN WIDTH BY 432 mm IN HEIGHT (B SIZE) WHEN
PLOTTED AT A SCALE OF 1:200.



STRATA PLAN EPS984

(SEE SHEET 14 FOR CONTINUATION)

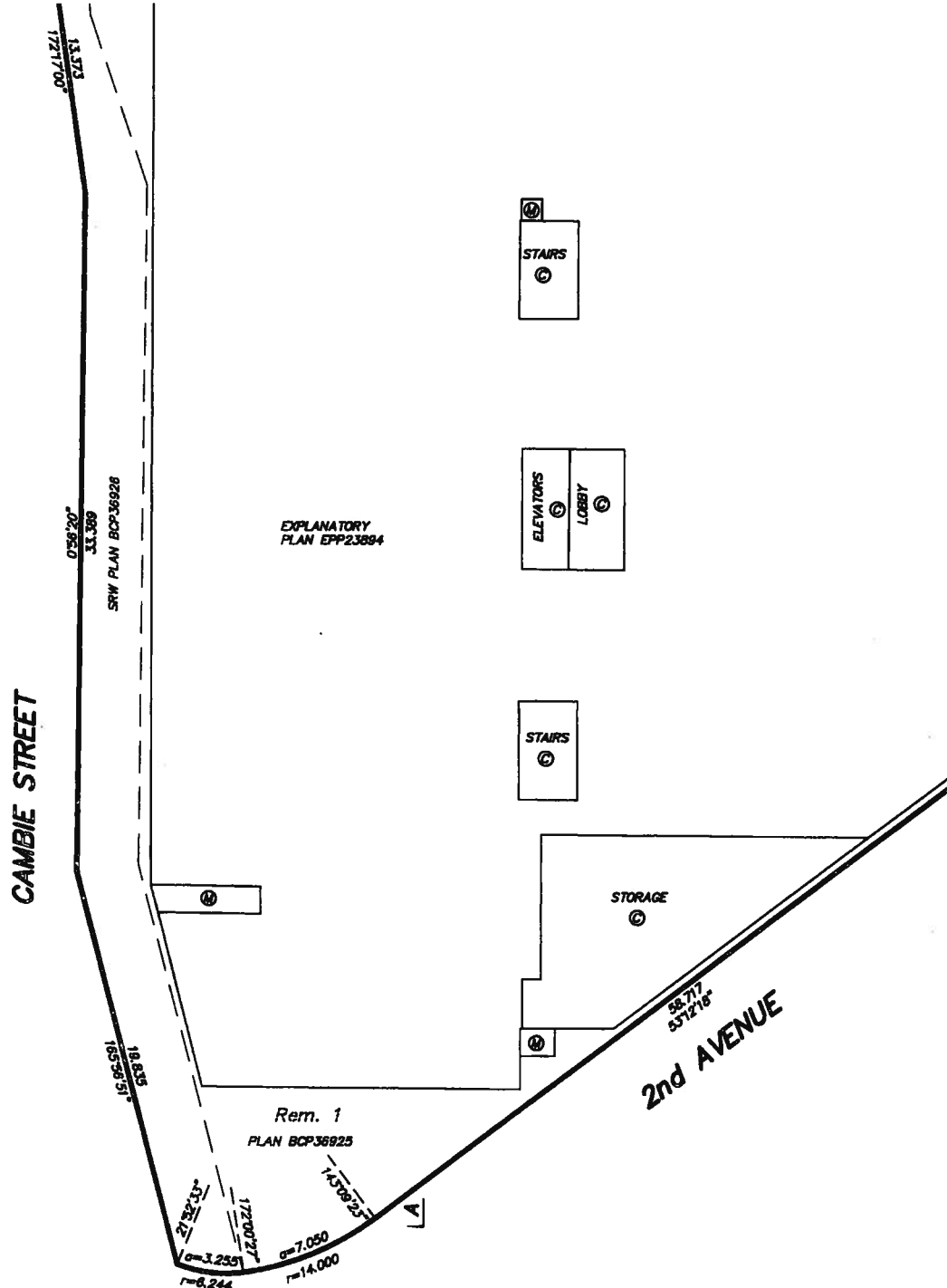

(SEE SHEET 17 FOR CONTINUATION)



GARY SUNDVICK, BCLS
Date: SEPTEMBER 7, 2012
File: 3688\Strata-Final
Dwg: 3688-Strata

**FLOOR PLAN
PARKING LEVEL P2**

0 5 10 15

SCALE 1:200 DISTANCES ARE IN METRES

THE INTENDED PLOT SCALE OF THIS PLAN IS 280 mm IN WIDTH BY 432 mm IN HEIGHT (B SIZE) WHEN PLOTTED AT A SCALE OF 1:200.



STRATA PLAN EPS984

(SEE SHEET 15 FOR CONTINUATION)

WYLE STREET

Rem. 1
PLAN BCP38925

ELEVATOR

(SEE SHEET 16 FOR CONTINUATION)

EXPLANATORY
PLAN EPP23884

2nd AVENUE

30.183
53°12'18"

14.57218°
1.324

58.712
53°12'18"



GARY SUNDWICK, BCLS
Date: SEPTEMBER 7, 2012
File: 3888-Strata-Final
Dwg: 3888-Strata

FLOOR PLAN PARKING LEVEL P1



SCALE 1:200 DISTANCES ARE IN METRES
THE INTENDED PLOT SCALE OF THIS PLAN IS 280 mm
IN WIDTH BY 432 mm IN HEIGHT (B SIZE) WHEN
PLOTTED AT A SCALE OF 1:200.



STRATA PLAN EPS984

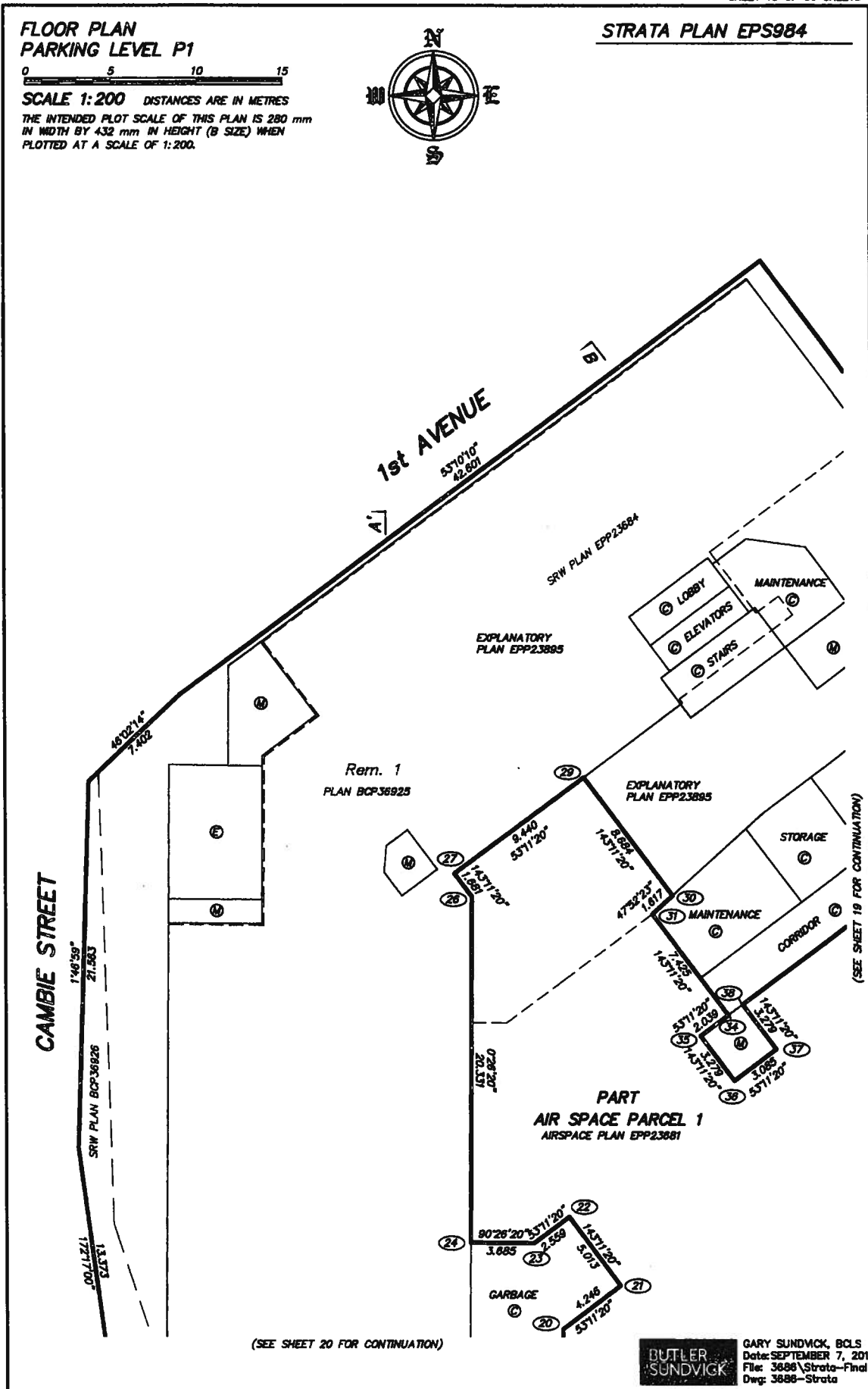

(SEE SHEET 20 FOR CONTINUATION)

(SEE SHEET 19 FOR CONTINUATION)



GARY SUNDVICK, BCLS
Date: SEPTEMBER 7, 2012
File: 3686\Strata-Final
Dwg: 3686-Strata

FLOOR PLAN
PARKING LEVEL P1

STRATA PLAN EPS984

0 5 10 15

SCALE 1:200 DISTANCES ARE IN METRES
THE INTENDED PLOT SCALE OF THIS PLAN IS 280 mm
IN WIDTH BY 432 mm IN HEIGHT (B SIZE) WHEN
PLOTTED AT A SCALE OF 1:200.

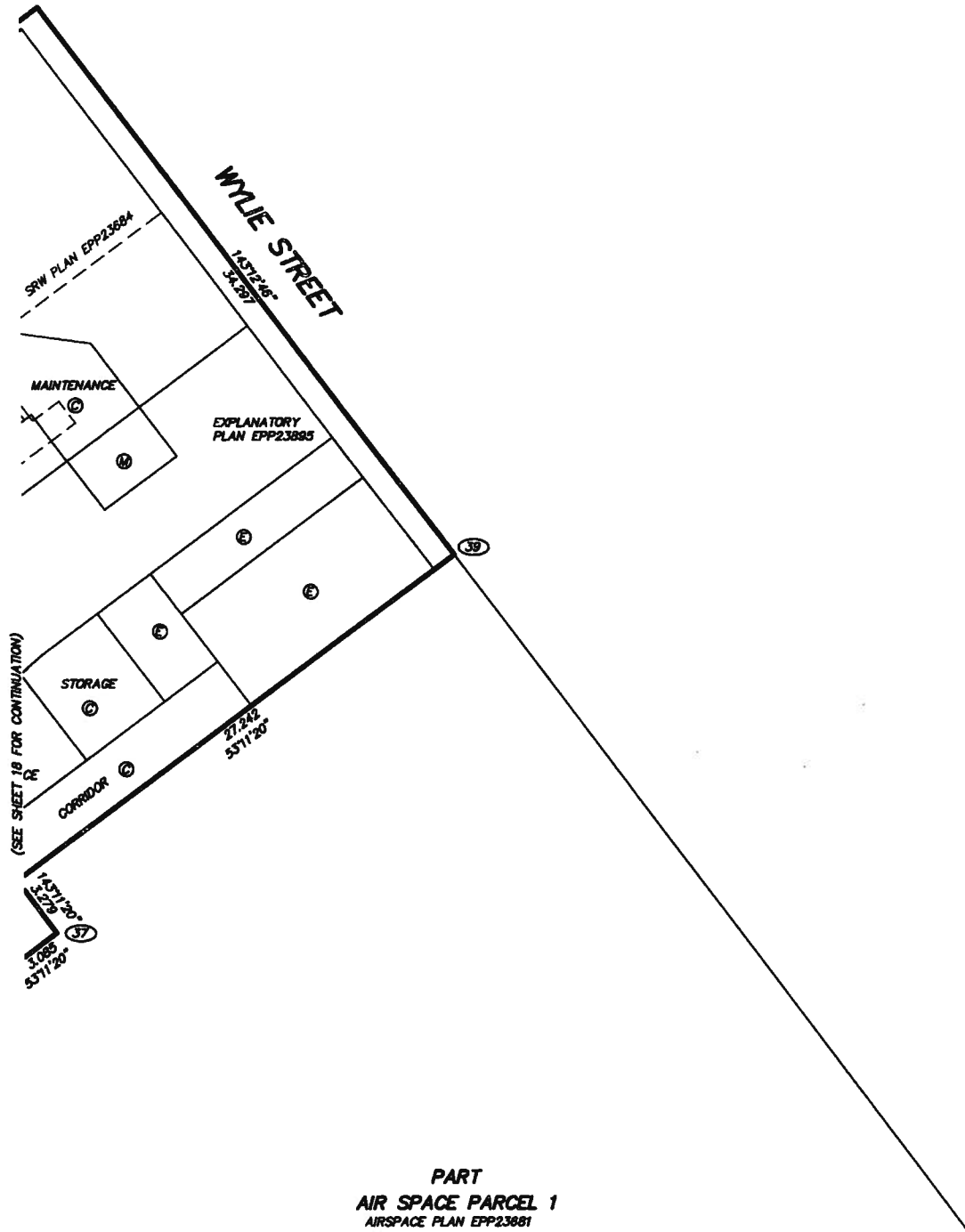

PART
AIR SPACE PARCEL 1
AIRSPACE PLAN EPP23681
(SEE SHEET 21 FOR CONTINUATION)

BUTLER SUNDWICK
GARY SUNDWICK, BCLS
Date: SEPTEMBER 7, 2012
File: 3688\Strata-Final
Dwg: 3688-Strata

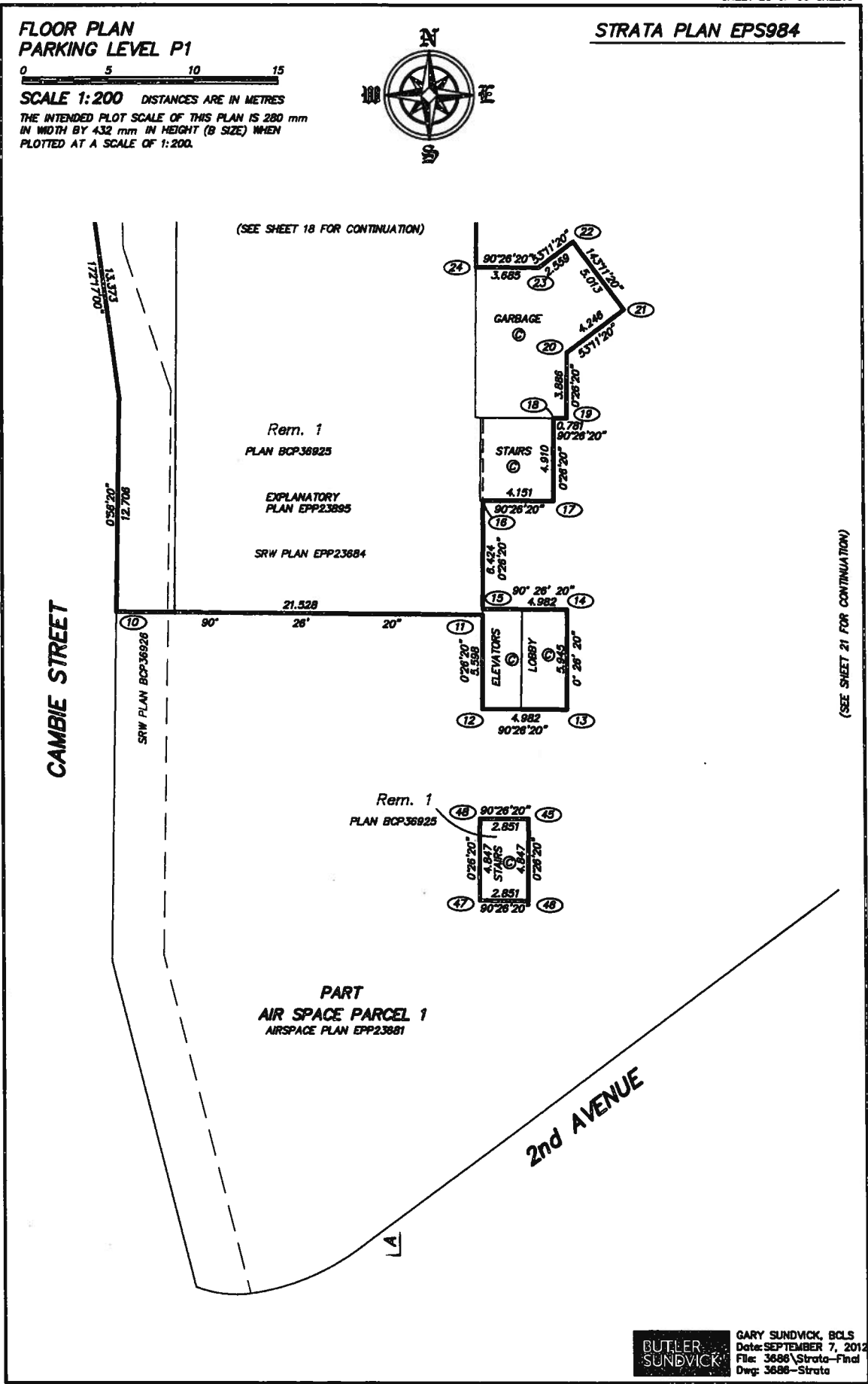

**BUTLER
SUNDBICK** GARY SUNDBICK, BCLS
Date: SEPTEMBER 7, 2012
File: 3686\Strata-Final
Dwg: 3686-Strata

**FLOOR PLAN
PARKING LEVEL P1**

0 5 10 15

SCALE 1:200 DISTANCES ARE IN METRES

THE INTENDED PLOT SCALE OF THIS PLAN IS 280 mm IN WIDTH BY 432 mm IN HEIGHT (B SIZE) WHEN PLOTTED AT A SCALE OF 1:200.



STRATA PLAN EPS984

(SEE SHEET 19 FOR CONTINUATION)

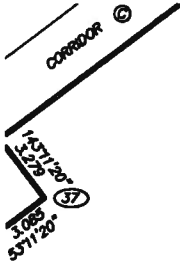

WYLE STREET

**PART
AIR SPACE PARCEL 1**
AIRSPACE PLAN EPP23681



Rem. 1
PLAN BCP36825

(SEE SHEET 20 FOR CONTINUATION)

2nd AVENUE



GARY SUNDVICK, BCLS
Date: SEPTEMBER 7, 2012
File: 3688\Strata-Final
Dwg: 3688-Strata

FLOOR PLAN
BUILDING A BASEMENT LEVEL

STRATA PLAN EPS984

0 5 10 15

SCALE 1:200 DISTANCES ARE IN METRES
THE INTENDED PLOT SCALE OF THIS PLAN IS 280 mm
IN WIDTH BY 432 mm IN HEIGHT (B SIZE) WHEN
PLOTTED AT A SCALE OF 1:200.

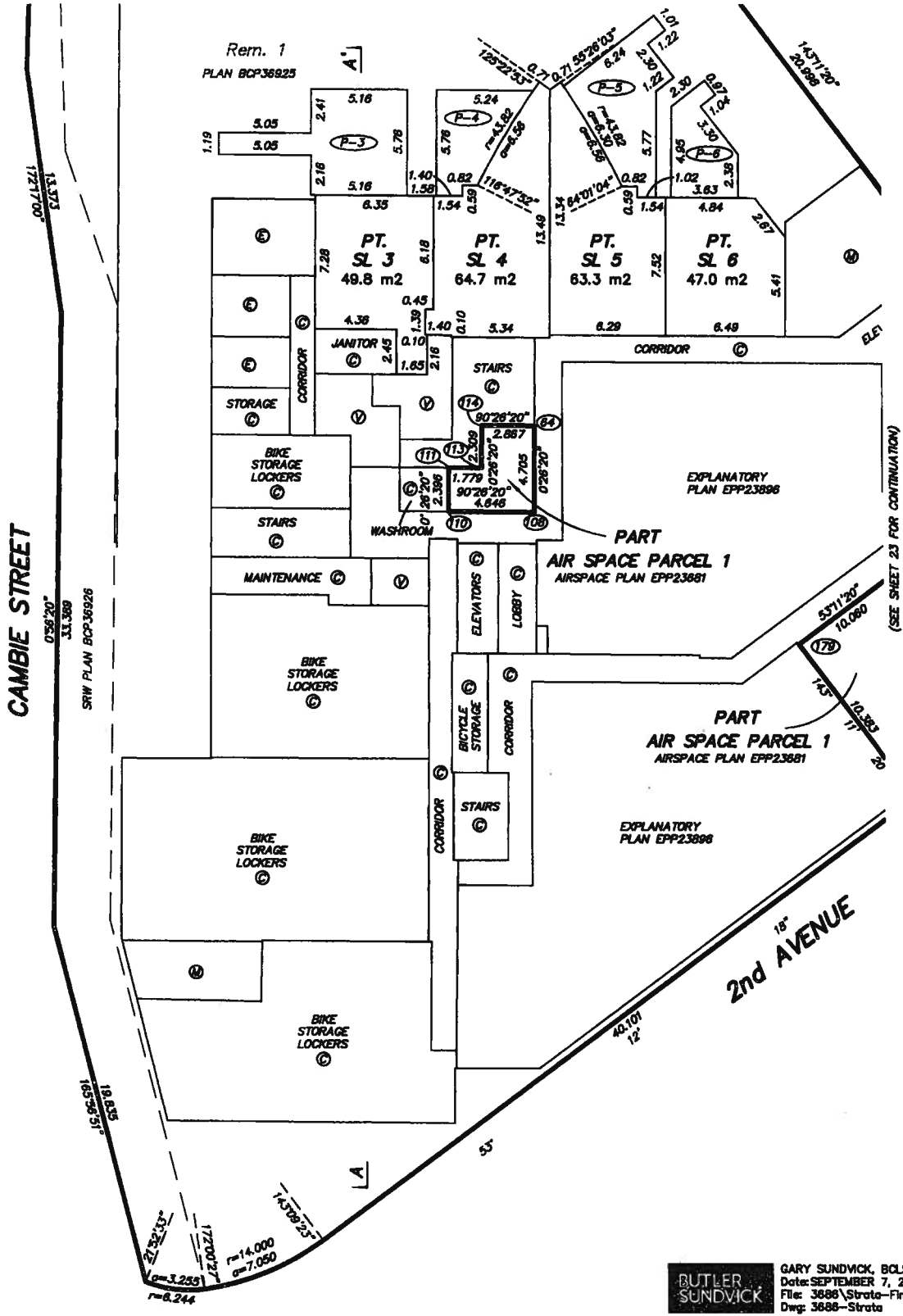

CAMBIE STREET

2nd AVENUE

BUTLER
SUNDVICK

GARY SUNDVICK, BCLS
Date: SEPTEMBER 7, 2012
File: 3886\Strata-Final
Dwg: 3886-Strata

(SEE SHEET 23 FOR CONTINUATION)

FLOOR PLAN
BUILDING A BASEMENT LEVEL

STRATA PLAN EPS984

0 5 10 15

SCALE 1:200 DISTANCES ARE IN METRES

THE INTENDED PLOT SCALE OF THIS PLAN IS 280 mm IN WIDTH BY 432 mm IN HEIGHT (B SIZE) WHEN PLOTTED AT A SCALE OF 1:200.

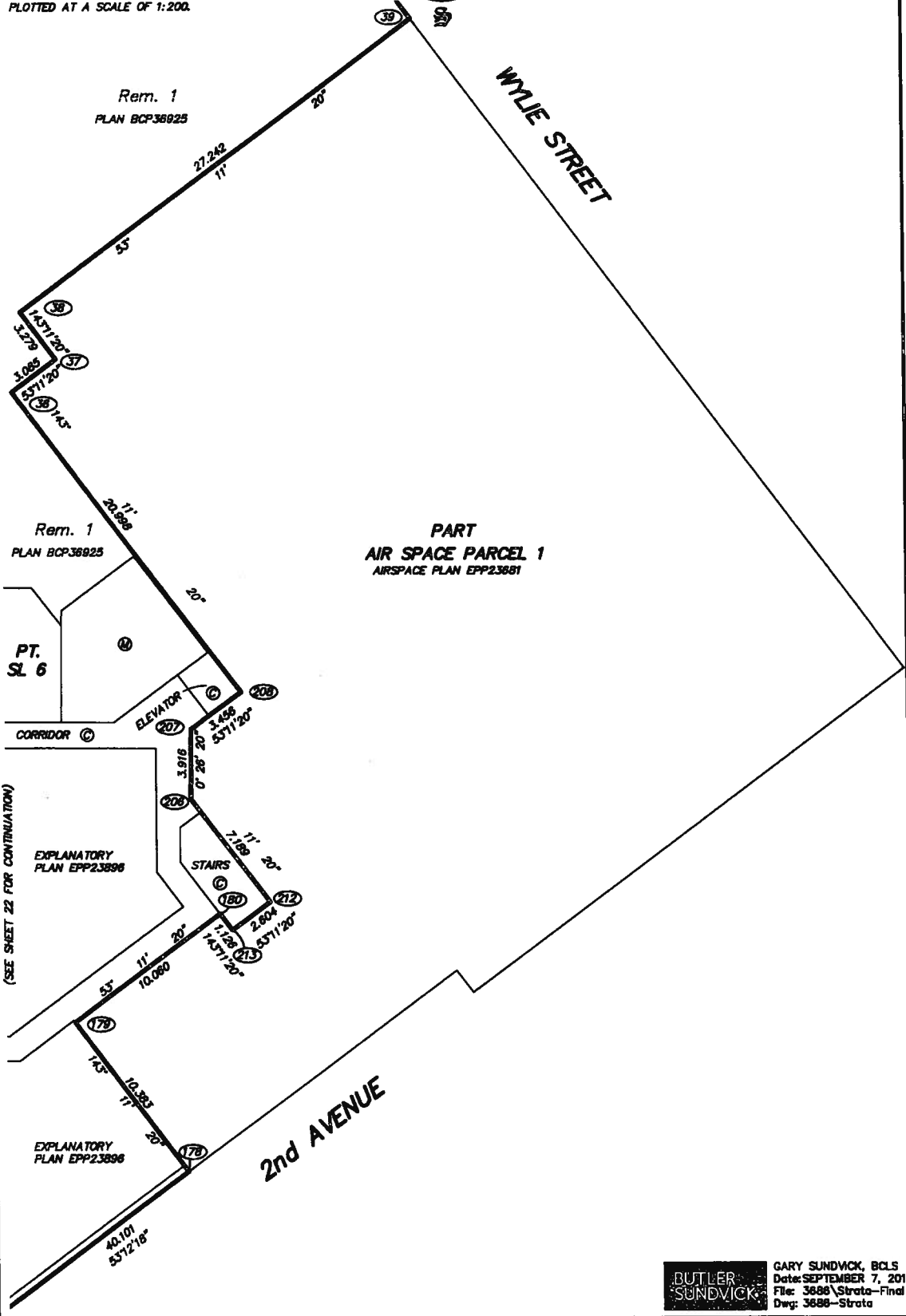

BUTLER SUNDVICK
GARY SUNDVICK, BCLS
Date: SEPTEMBER 7, 2012
File: 3888\Strata-Final
Dwg: 3888-Strata

FLOOR PLAN BUILDING A LEVEL 1

STRATA PLAN EPS984

0 5 10 15

SCALE 1:200 DISTANCES ARE IN METRES THE INTENDED PLOT SCALE OF THIS PLAN IS 280 mm IN WIDTH BY 432 mm IN HEIGHT (B SIZE) WHEN PLOTTED AT A SCALE OF 1:200.

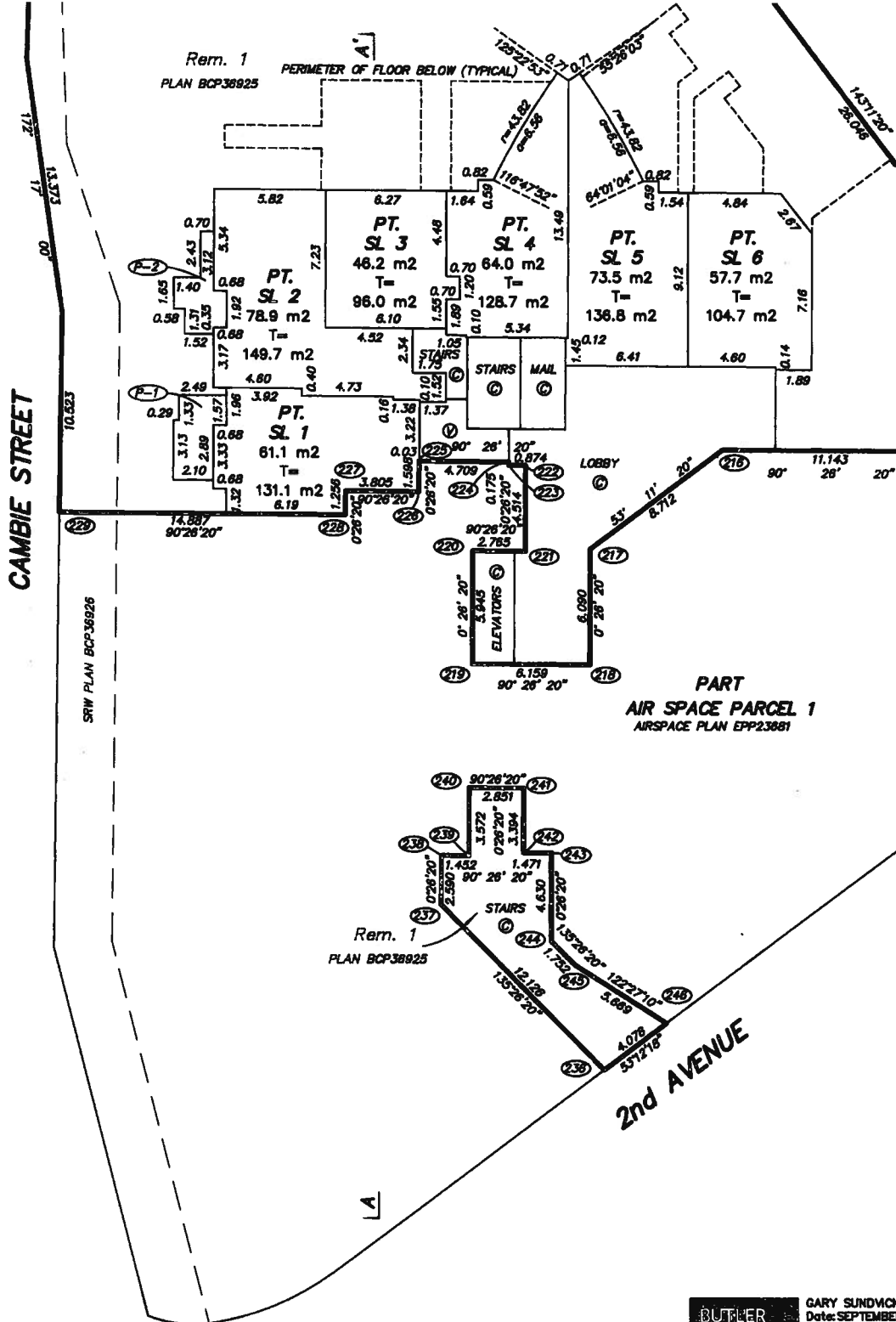

(SEE SHEET 23 FOR CONTINUATION)

**FLOOR PLAN
BUILDING A LEVEL 1**

STRATA PLAN EPS984



SCALE 1:200 DISTANCES ARE IN METRES

THE INTENDED PLOT SCALE OF THIS PLAN IS 280 mm IN WIDTH BY 432 mm IN HEIGHT (B SIZE) WHEN PLOTTED AT A SCALE OF 1:200.

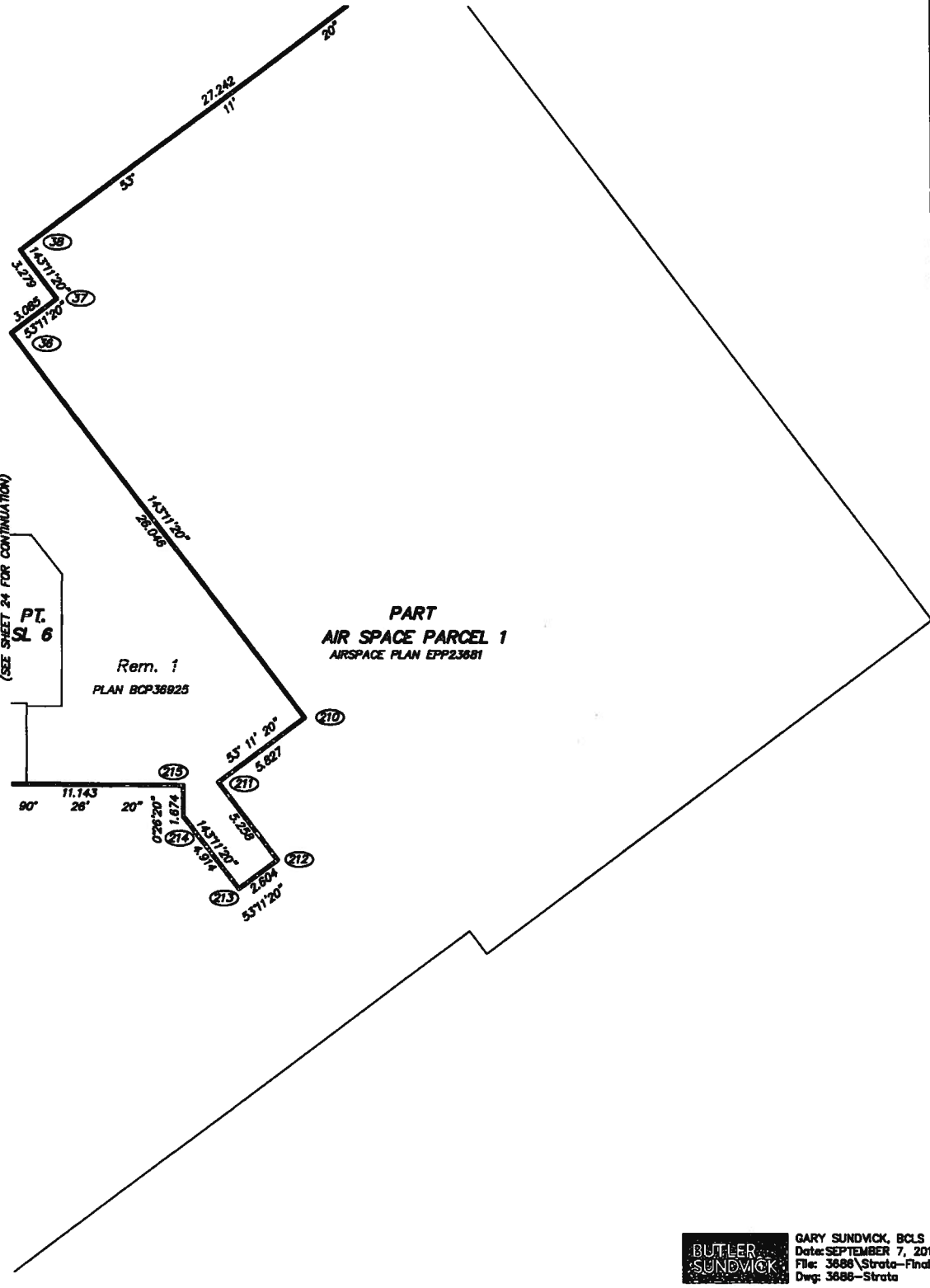

**BUTLER
SUNDVICK**
 GARY SUNDVICK, BCLS
 Date: SEPTEMBER 7, 2012
 File: 3688\Strata-Final
 Dwg: 3688-Strata

FLOOR PLAN BUILDING A LEVEL 2

0 5 10 15

SCALE 1:200 DISTANCES ARE IN METRES
THE INTENDED PLOT SCALE OF THIS PLAN IS 280 mm
IN WIDTH BY 432 mm IN HEIGHT (B SIZE) WHEN
PLOTTED AT A SCALE OF 1:200.



STRATA PLAN EPS984

PERIMETER OF FLOOR BELOW

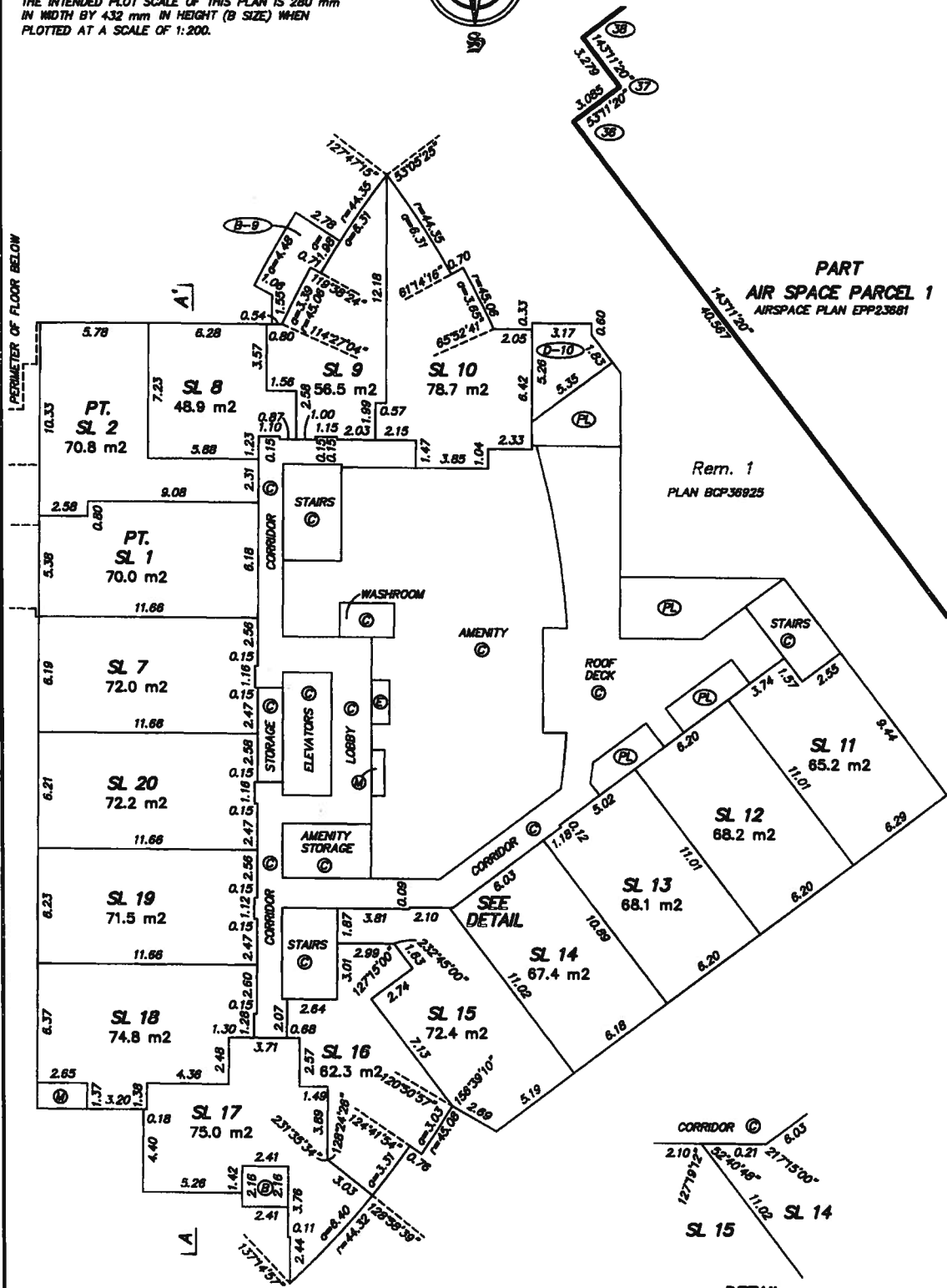

PART
AIR SPACE PARCEL 1
AIRSPACE PLAN EPP23681

Rem. 1
PLAN BCP36925

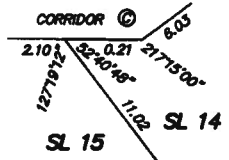

DETAIL
NOT TO SCALE

**BUTLER
SUNDVICK** GARY SUNDVICK, BCLS
Date: SEPTEMBER 7, 2012
File: 3688-Strata-Final
Dwg: 3688-Strata

FLOOR PLAN BUILDING A LEVEL 3

0 5 10 15

SCALE 1:200 DISTANCES ARE IN METRES

THE INTENDED PLOT SCALE OF THIS PLAN IS 280 mm IN WIDTH BY 432 mm IN HEIGHT (B SIZE) WHEN PLOTTED AT A SCALE OF 1:200.

STRATA PLAN EPS984

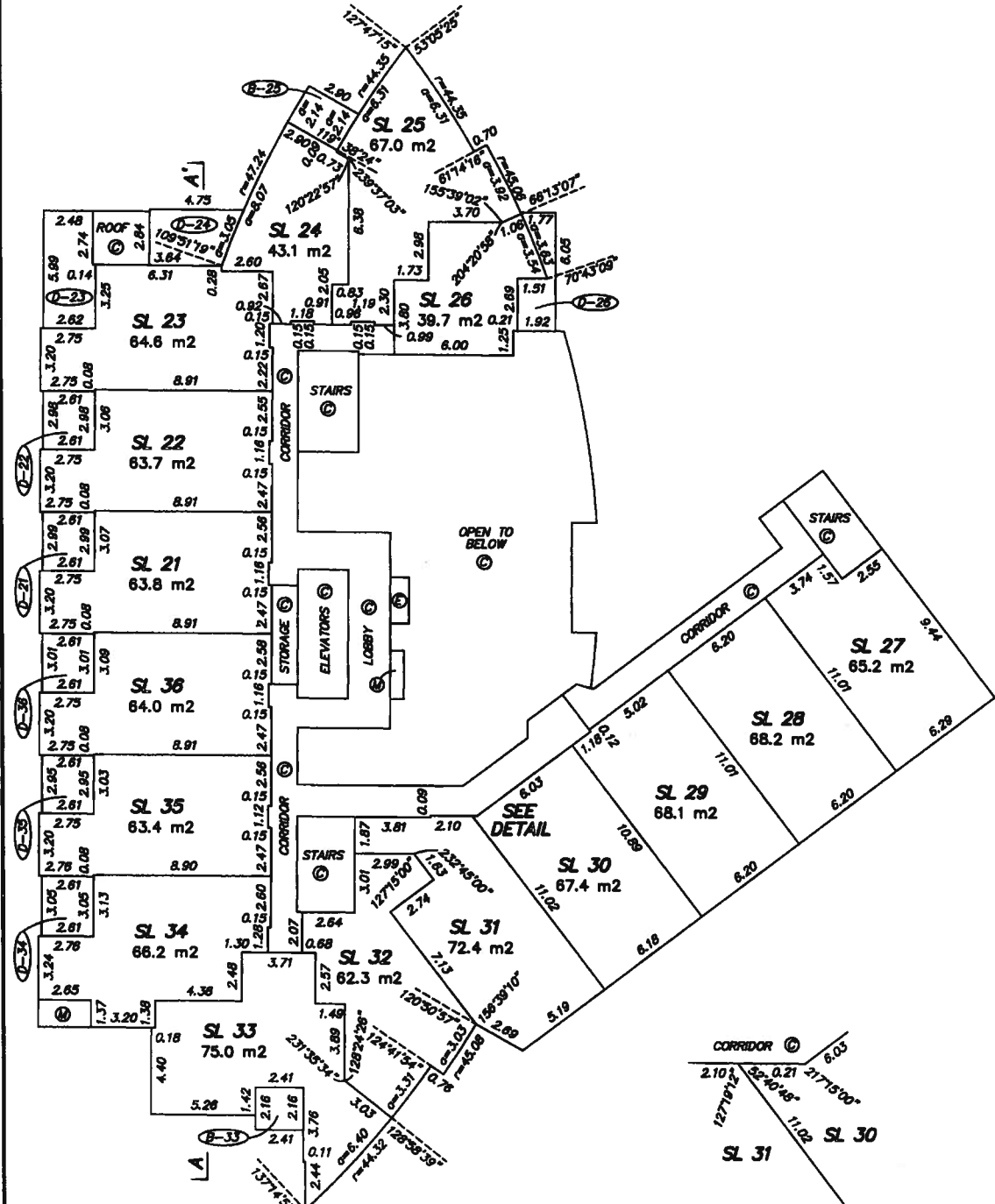

DETAIL
NOT TO SCALE

BUTLER SANDWICK
 GARY SANDWICK, BCLS
 Date: SEPTEMBER 7, 2012
 File: 3888-Strata-Final
 Dwg: 3888-Strata

FLOOR PLAN
BUILDING A LEVEL 4

STRATA PLAN EPS984



SCALE 1:200 DISTANCES ARE IN METRES
THE INTENDED PLOT SCALE OF THIS PLAN IS 280 mm
IN WIDTH BY 432 mm IN HEIGHT (B SIZE) WHEN
PLOTTED AT A SCALE OF 1:200.

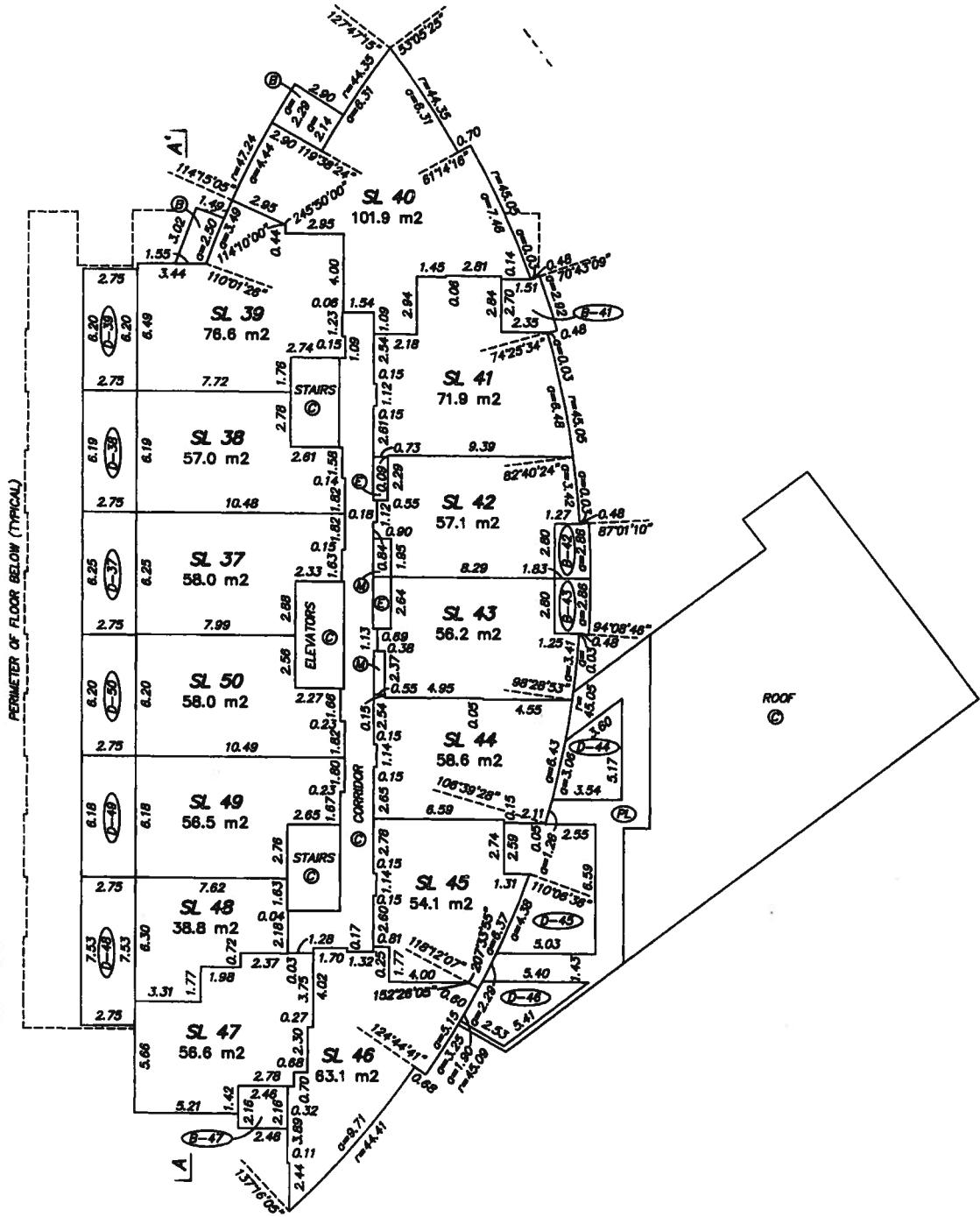

PERIMETER OF FLOOR BELOW (TYPICAL)

**BUTLER
SUNDVICK** GARY SUNDVICK, BCLS
Date: SEPTEMBER 7, 2012
File: 3888\Strata-Final
Dwg: 3888-Strata

FLOOR PLAN BUILDING A LEVEL 5

STRATA PLAN EPS984

0 5 10 15

SCALE 1:200 DISTANCES ARE IN METRES

THE INTENDED PLOT SCALE OF THIS PLAN IS 280 mm IN WIDTH BY 432 mm IN HEIGHT (B SIZE) WHEN PLOTTED AT A SCALE OF 1:200.

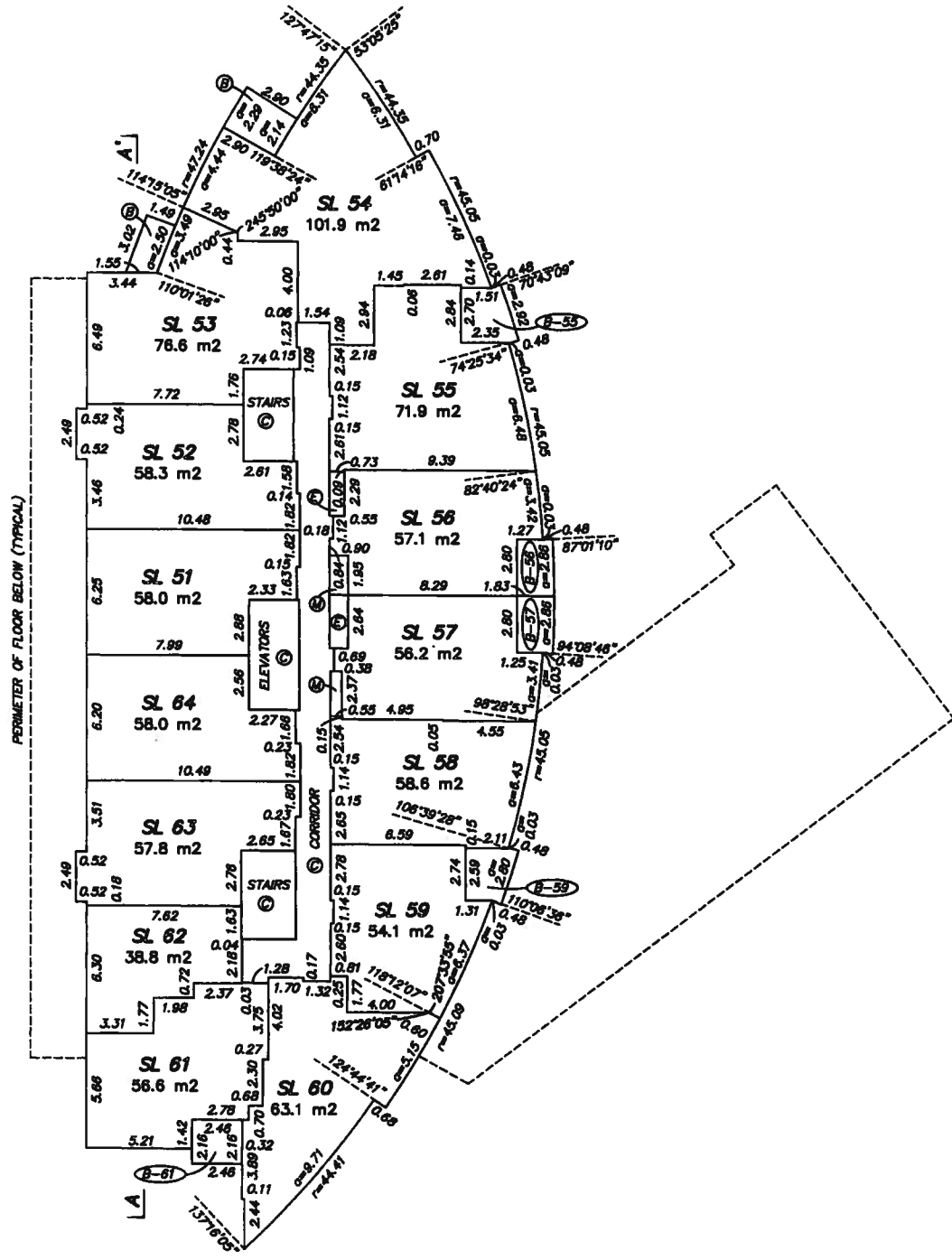

BUTLER SUNDVICK
 GARY SUNDVICK, BCLS
 Date: SEPTEMBER 7, 2012
 File: 3688\Strata-Final
 Dwg: 3688-Strata

FLOOR PLAN
BUILDING A LEVEL 6

STRATA PLAN EPS984



SCALE 1:200 DISTANCES ARE IN METRES
THE INTENDED PLOT SCALE OF THIS PLAN IS 280 mm
IN WIDTH BY 432 mm IN HEIGHT (B SIZE) WHEN
PLOTTED AT A SCALE OF 1:200.

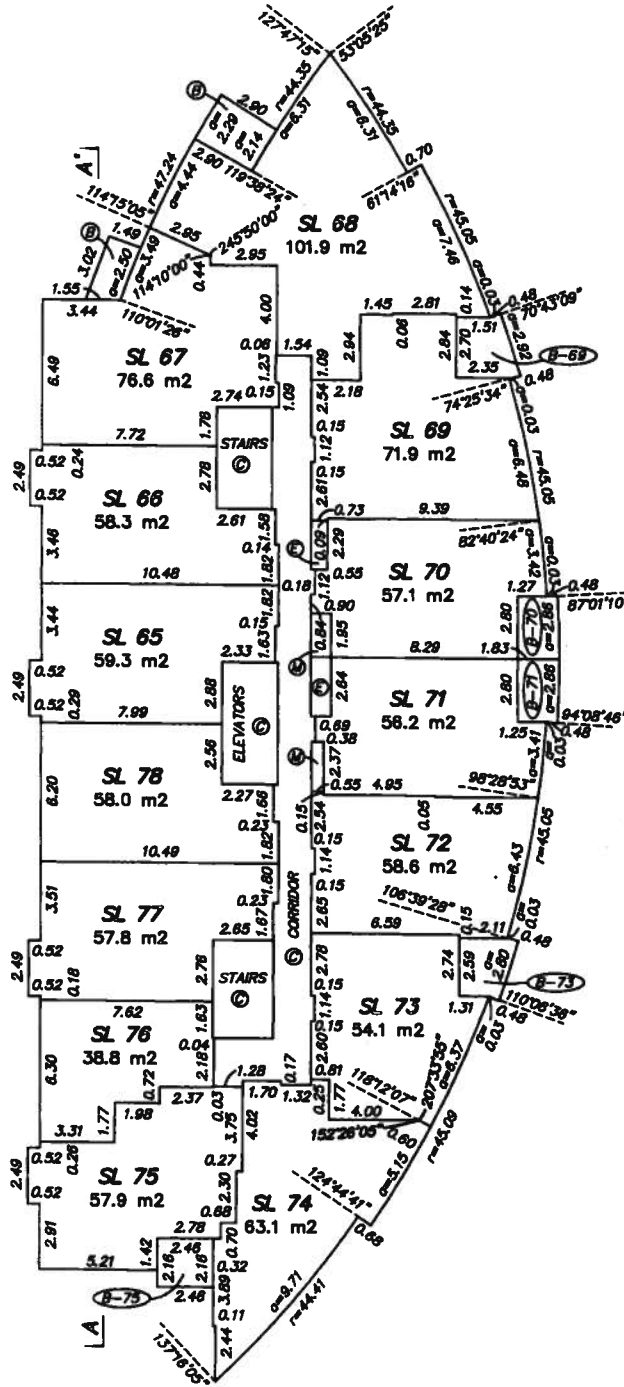

GARY SANDWICK, BCLS
Date: SEPTEMBER 7, 2012
File: 3888-Strata-Final
Dwg: 3888-Strata

FLOOR PLAN
BUILDING A LEVEL 7

STRATA PLAN EPS984

0 5 10 15

SCALE 1:200 DISTANCES ARE IN METRES

THE INTENDED PLOT SCALE OF THIS PLAN IS 280 mm IN WIDTH BY 432 mm IN HEIGHT (B SIZE) WHEN PLOTTED AT A SCALE OF 1:200.

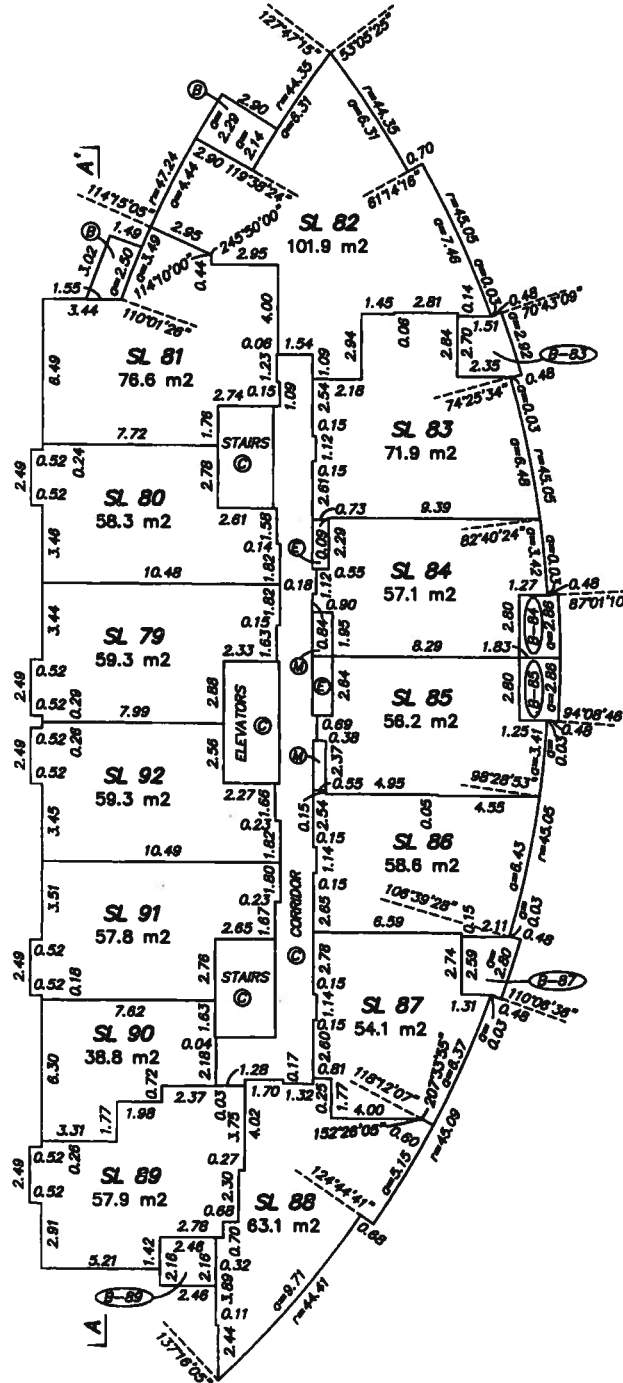

BUTLER SUNDVICK
 GARY SUNDVICK, BCLS
 Date: SEPTEMBER 7, 2012
 File: 3888-Strata-Final
 Dwg: 3888-Strata

FLOOR PLAN
BUILDING A LEVEL 8

STRATA PLAN EPS984



SCALE 1:200 DISTANCES ARE IN METRES
THE INTENDED PLOT SCALE OF THIS PLAN IS 280 mm
IN WIDTH BY 432 mm IN HEIGHT (B SIZE) WHEN
PLOTTED AT A SCALE OF 1:200.

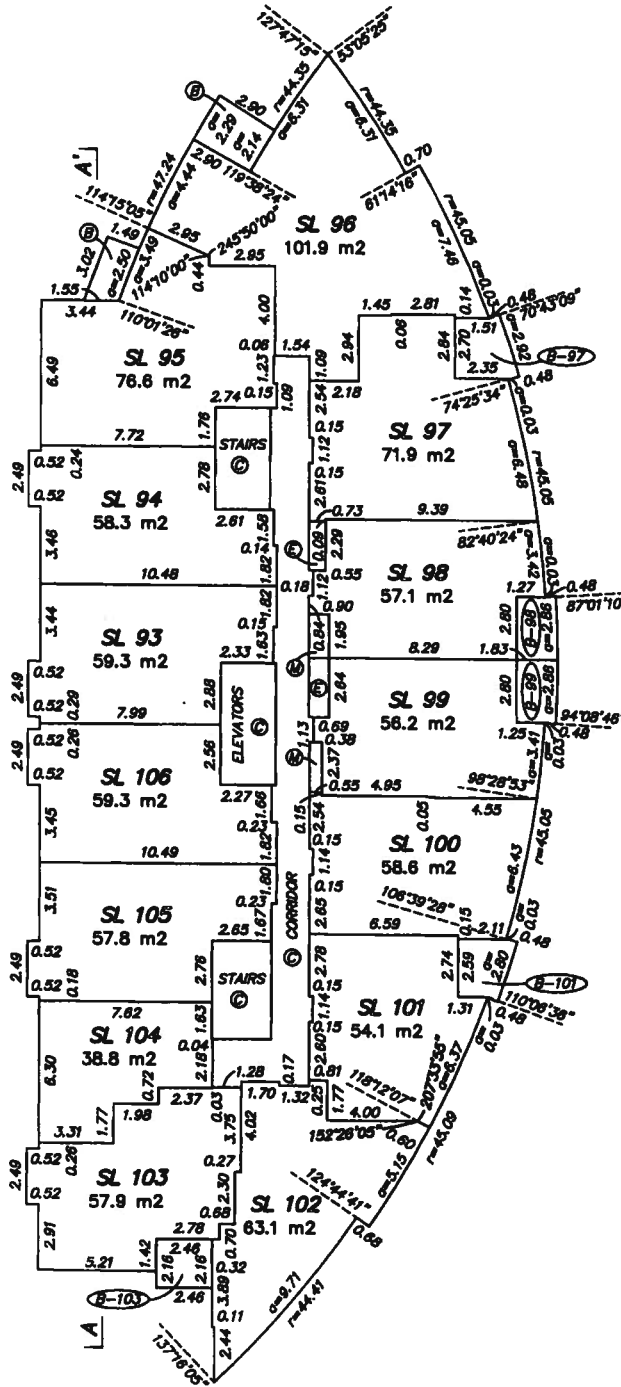

GARY SUNDVICK, BCLS
Date: SEPTEMBER 7, 2012
File: 3686\Strata-Final
Dwg: 3686-Strata

FLOOR PLAN BUILDING A LEVEL 9

STRATA PLAN EPS984

0 5 10 15

SCALE 1:200 DISTANCES ARE IN METRES

THE INTENDED PLOT SCALE OF THIS PLAN IS 280 mm IN WIDTH BY 432 mm IN HEIGHT (B SIZE) WHEN PLOTTED AT A SCALE OF 1:200.

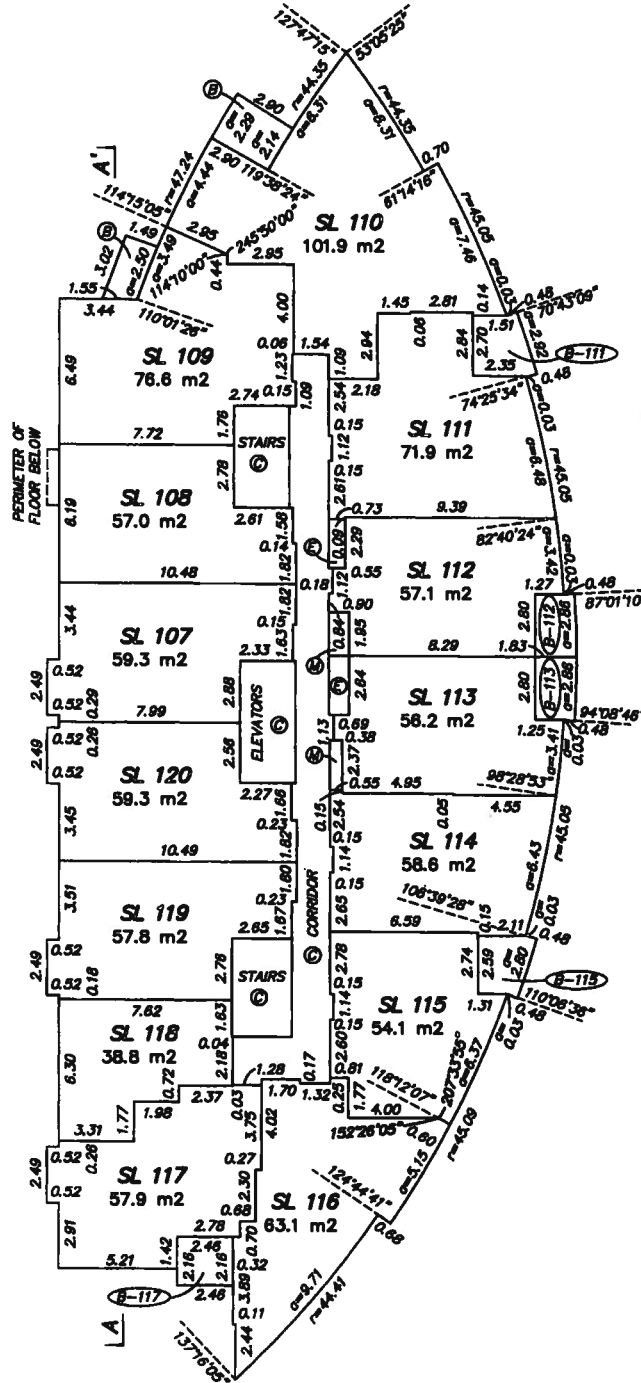

BUTLER SUNDVICK
 GARY SUNDVICK, BCLS
 Date: SEPTEMBER 7, 2012
 File: 3686\Strata-Final
 Dwg: 3686-Strata

FLOOR PLAN BUILDING A LEVEL 10

STRATA PLAN EPS984

0 5 10 15

SCALE 1:200 DISTANCES ARE IN METRES
THE INTENDED PLOT SCALE OF THIS PLAN IS 280 mm
IN WIDTH BY 432 mm IN HEIGHT (B SIZE) WHEN
PLOTTED AT A SCALE OF 1:200.

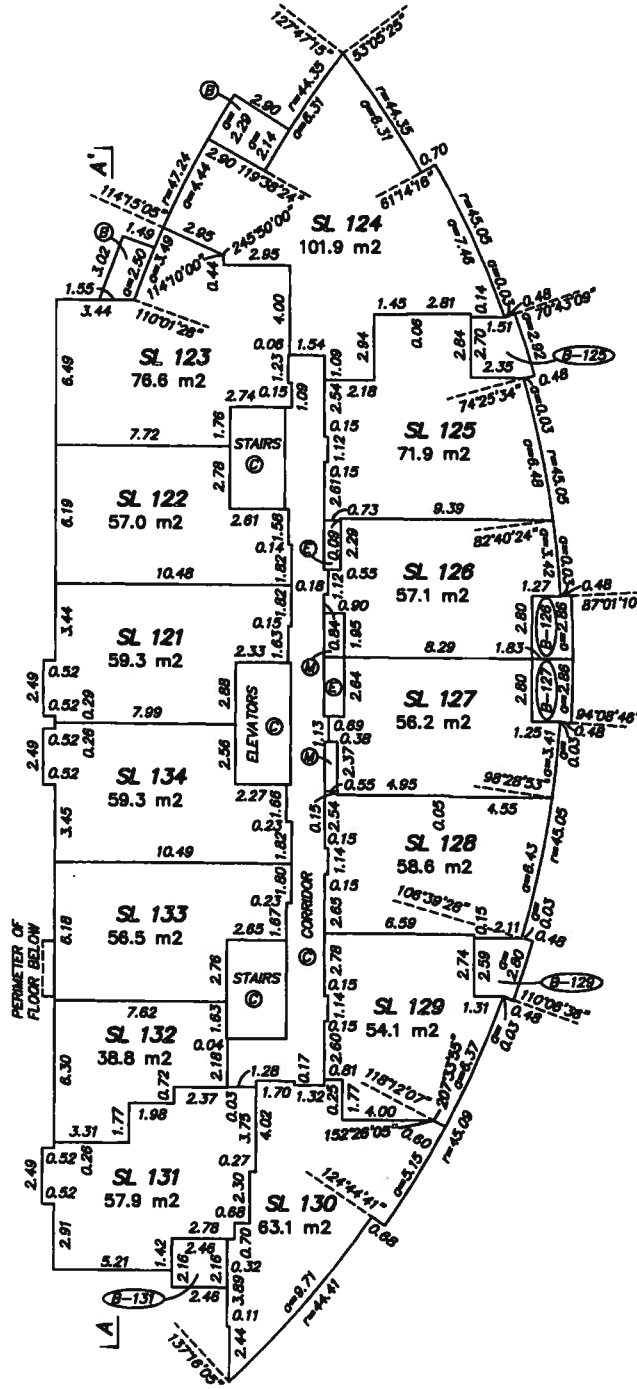

BUTLER SUNDVICK
 GARY SUNDVICK, BCLS
 Date: SEPTEMBER 7, 2012
 File: 3688\Strata-Final
 Dwg: 3688-Strata

FLOOR PLAN BUILDING A LEVEL 11

STRATA PLAN EPS984



SCALE 1:200 DISTANCES ARE IN METRES

THE INTENDED PLOT SCALE OF THIS PLAN IS 280 mm IN WIDTH BY 432 mm IN HEIGHT (B SIZE) WHEN PLOTTED AT A SCALE OF 1:200.

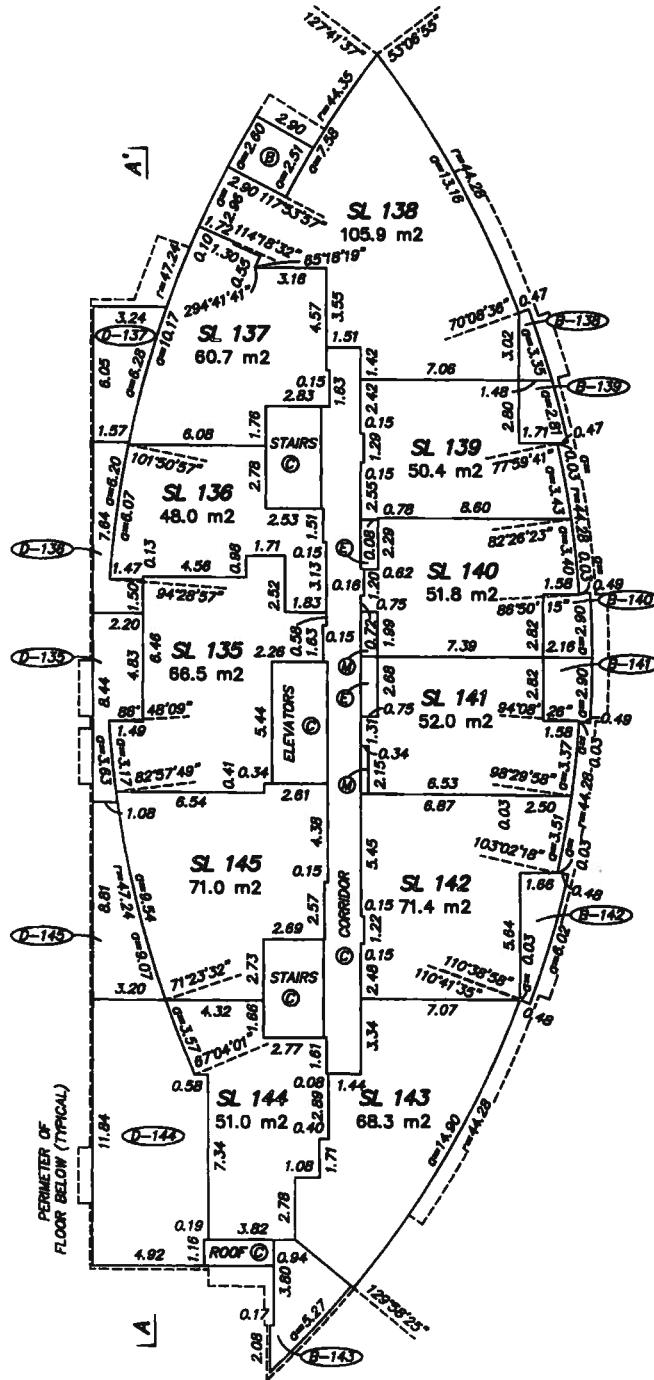

PERIMETER OF FLOOR BELOW (TYPICAL)

BUTLER SUNDVICK
GARY SUNDVICK, BCLS
Date: SEPTEMBER 7, 2012
File: 3686-Strata-Final
Dwg: 3686-Strata

FLOOR PLAN BUILDING A LEVEL 12

STRATA PLAN EPS984

0 5 10 15

SCALE 1:200 DISTANCES ARE IN METRES
THE INTENDED PLOT SCALE OF THIS PLAN IS 280 mm
IN WIDTH BY 432 mm IN HEIGHT (B SIZE) WHEN
PLOTTED AT A SCALE OF 1:200.

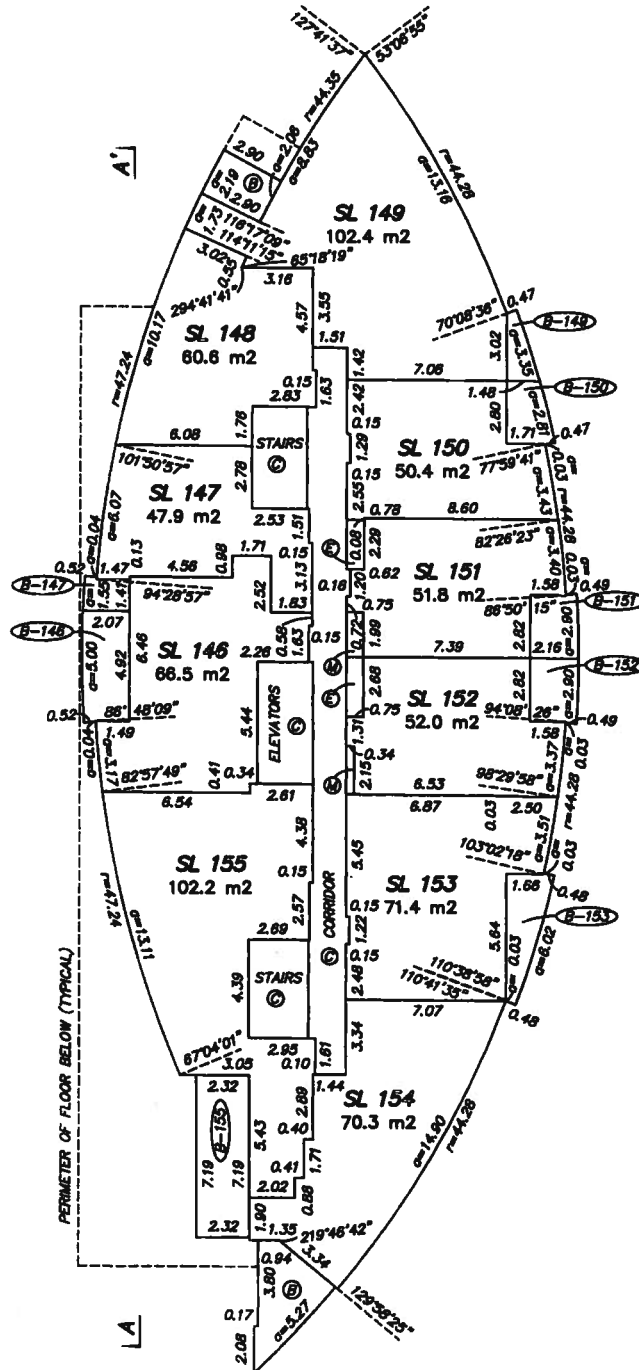

GARY SUNDVICK, BCLS
Date: SEPTEMBER 7, 2012
File: 3686-Strata-Final
Dwg: 3686-Strata

FLOOR PLAN BUILDING A LEVEL 13



SCALE 1:200 DISTANCES ARE IN METRES

THE INTENDED PLOT SCALE OF THIS PLAN IS 280 mm IN WIDTH BY 432 mm IN HEIGHT (B SIZE) WHEN PLOTTED AT A SCALE OF 1:200.

STRATA PLAN EPS984

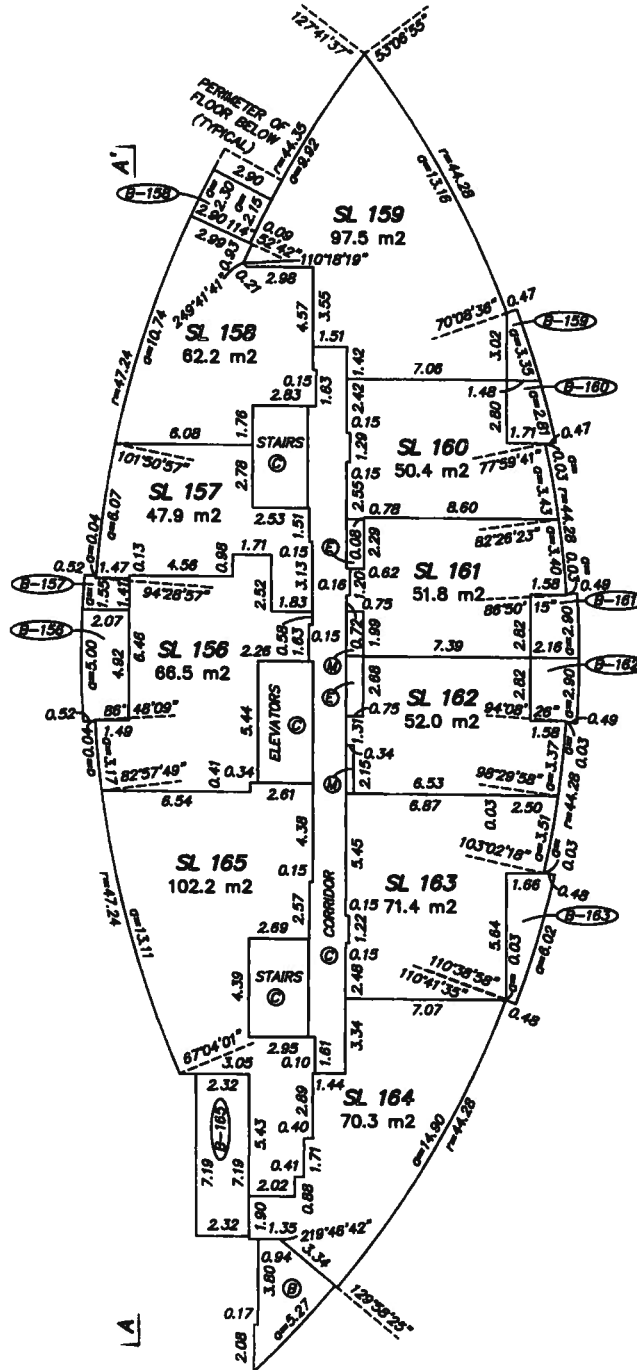

**BUTLER
SUNDVICK**
 GARY SUNDVICK, BCLS
 Date: SEPTEMBER 7, 2012
 File: 3688\Strata-Final
 Dwg: 3688-Strata

**FLOOR PLAN
BUILDING A ROOF**

STRATA PLAN EPS984



SCALE 1:200 DISTANCES ARE IN METRES
THE INTENDED PLOT SCALE OF THIS PLAN IS 280 mm
IN WIDTH BY 432 mm IN HEIGHT (B SIZE) WHEN
PLOTTED AT A SCALE OF 1:200.

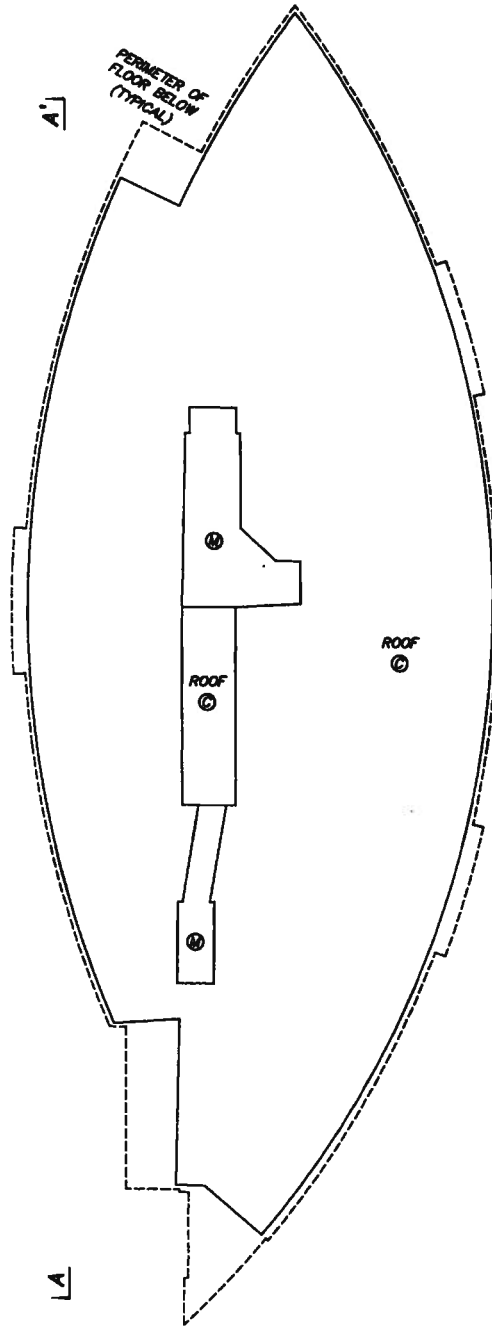

GARY SUNDVICK, BCLS
Date: SEPTEMBER 7, 2012
File: 3688\Strata-Final
Dwg: 3688-Strata

FLOOR PLAN
BUILDING B LEVEL 1

STRATA PLAN EPS984



SCALE 1:200 DISTANCES ARE IN METRES
THE INTENDED PLOT SCALE OF THIS PLAN IS 280 mm
IN WIDTH BY 432 mm IN HEIGHT (B SIZE) WHEN
PLOTTED AT A SCALE OF 1:200.

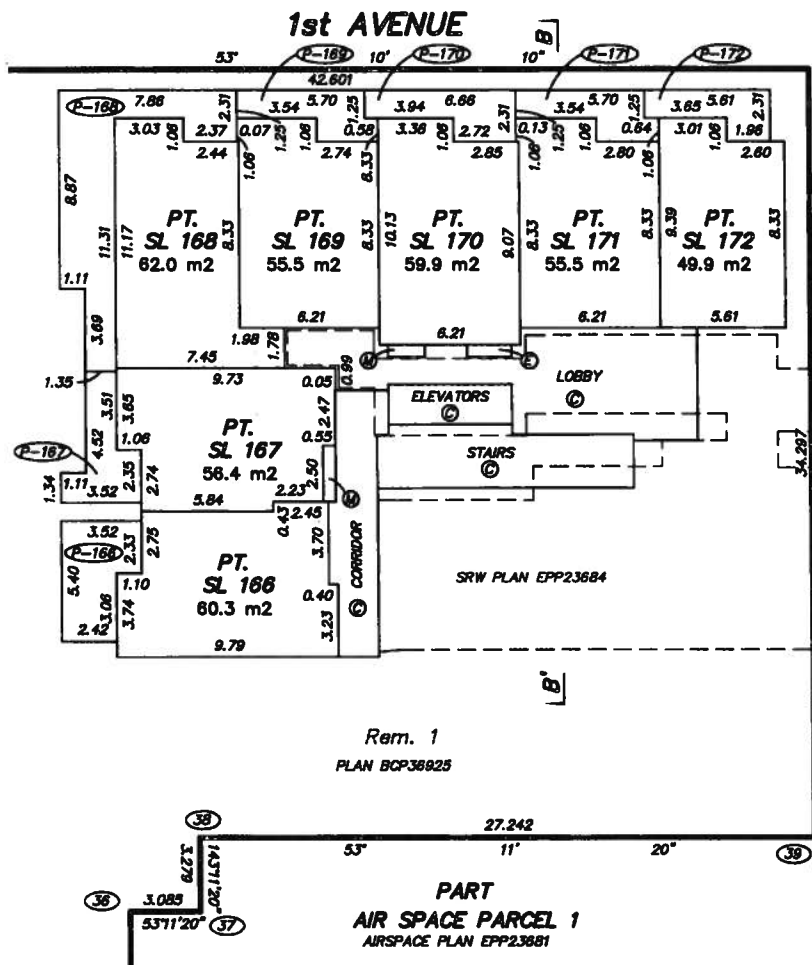

WYLE STREET



GARY SUNDVICK, BCLS
Date: SEPTEMBER 7, 2012
File: 3686 Strata-Final
Dwg: 3686-Strata

FLOOR PLAN BUILDING B LEVEL 2

STRATA PLAN EPS984



SCALE 1:200 DISTANCES ARE IN METRES
THE INTENDED PLOT SCALE OF THIS PLAN IS 280 mm
IN WIDTH BY 432 mm IN HEIGHT (B SIZE) WHEN
PLOTTED AT A SCALE OF 1:200.

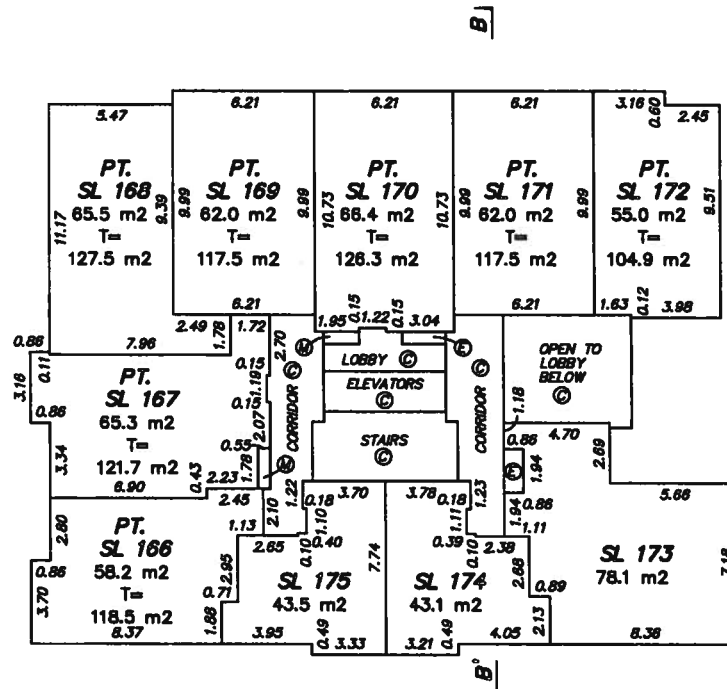

GARY SUNDVICK, BCLS
Date: SEPTEMBER 7, 2012
File: 3688\Strata-Final
Dwg: 3688-Strata

FLOOR PLAN BUILDING B LEVEL 3



SCALE 1:200 DISTANCES ARE IN METRES
THE INTENDED PLOT SCALE OF THIS PLAN IS 280 mm
IN WIDTH BY 432 mm IN HEIGHT (B SIZE) WHEN
PLOTTED AT A SCALE OF 1:200.



STRATA PLAN EPS984

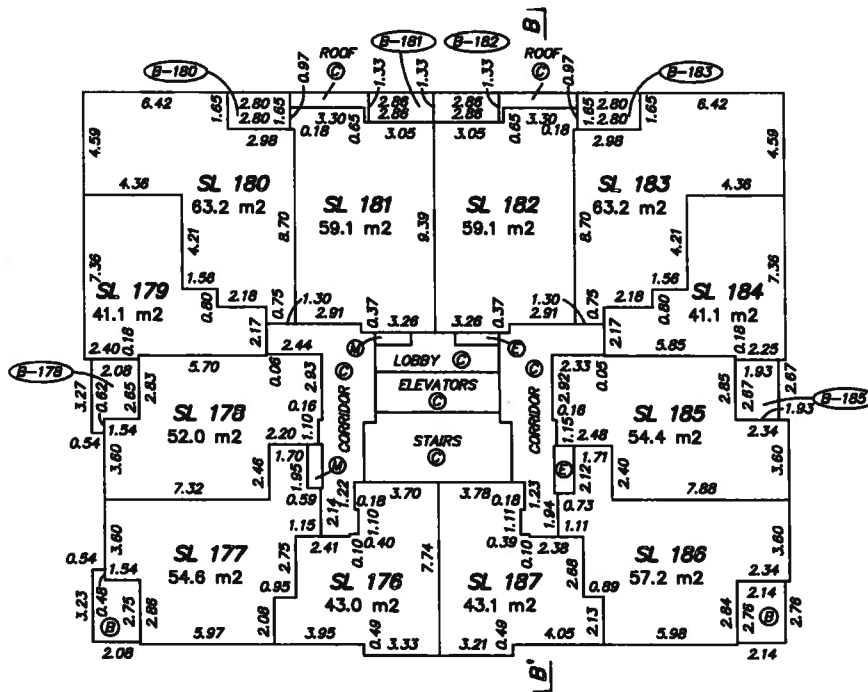

GARY SUNDWICK, BCLS
Date: SEPTEMBER 7, 2012
File: 3888\Strata-Final
Dwg: 3888-Strata

FLOOR PLAN
BUILDING B LEVEL 4

STRATA PLAN EPS984



SCALE 1:200 DISTANCES ARE IN METRES
THE INTENDED PLOT SCALE OF THIS PLAN IS 280 mm
IN WIDTH BY 432 mm IN HEIGHT (B SIZE) WHEN
PLOTTED AT A SCALE OF 1:200.

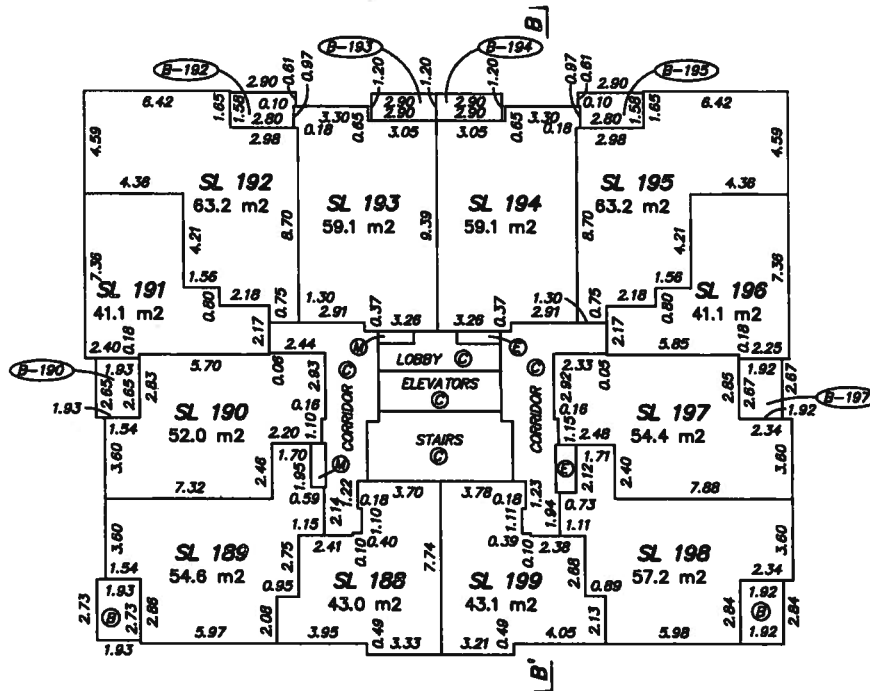

GARY SUNDVICK, BCLS
Date: SEPTEMBER 7, 2012
File: 3686\Strata-Final
Dwg: 3686-Strata

FLOOR PLAN BUILDING B LEVEL 5

0 5 10 15

SCALE 1:200 DISTANCES ARE IN METRES

THE INTENDED PLOT SCALE OF THIS PLAN IS 280 mm IN WIDTH BY 432 mm IN HEIGHT (B SIZE) WHEN PLOTTED AT A SCALE OF 1:200.



STRATA PLAN EPS984

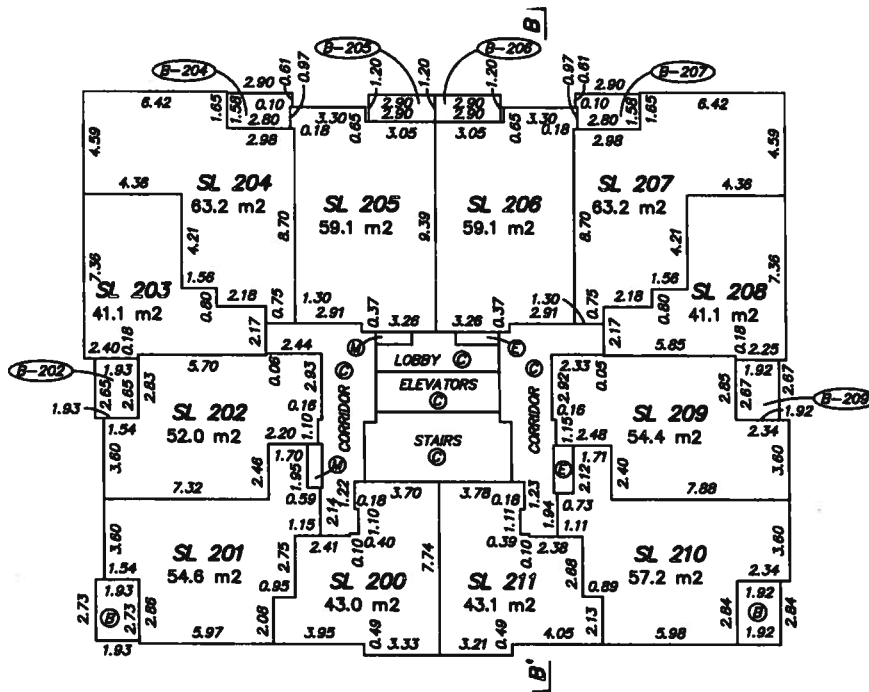

GARY SUNDVICK, BCLS
Date: SEPTEMBER 7, 2012
File: 3688\Strata-Final
Dwg: 3688-Strata

FLOOR PLAN
BUILDING B LEVEL 6

STRATA PLAN EPS984



SCALE 1:200 DISTANCES ARE IN METRES
THE INTENDED PLOT SCALE OF THIS PLAN IS 280 mm
IN WIDTH BY 432 mm IN HEIGHT (B SIZE) WHEN
PLOTTED AT A SCALE OF 1:200.

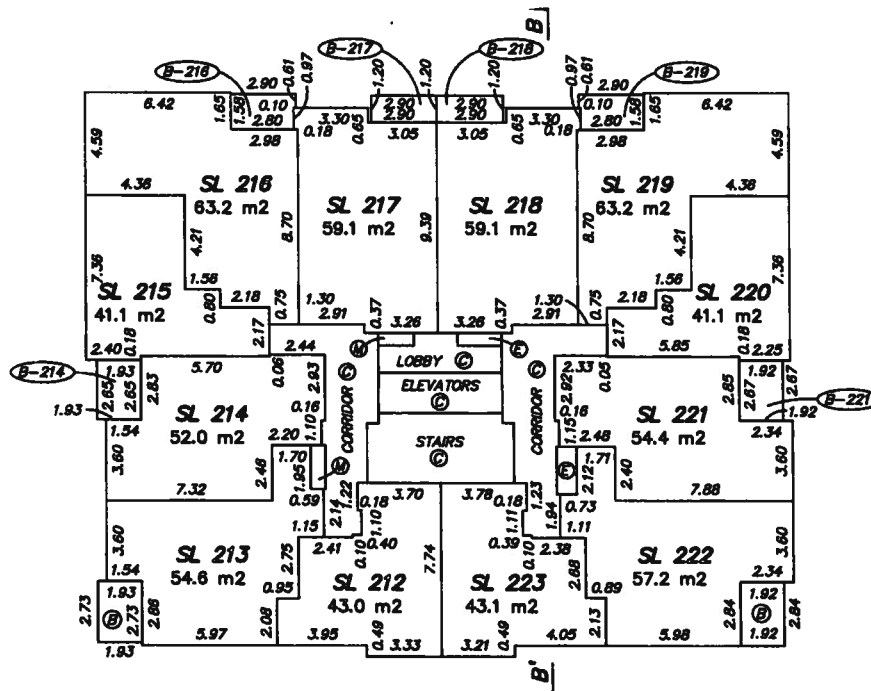

**BUTLER
SUNDVICK**
GARY SUNDVICK, BCLS
Date: SEPTEMBER 7, 2012
File: 3688\Strata-Final
Dwg: 3688-Strata

FLOOR PLAN
BUILDING B LEVEL 7

STRATA PLAN EPS984

0 5 10 15

SCALE 1:200 DISTANCES ARE IN METRES

THE INTENDED PLOT SCALE OF THIS PLAN IS 280 mm IN WIDTH BY 432 mm IN HEIGHT (B SIZE) WHEN PLOTTED AT A SCALE OF 1:200.

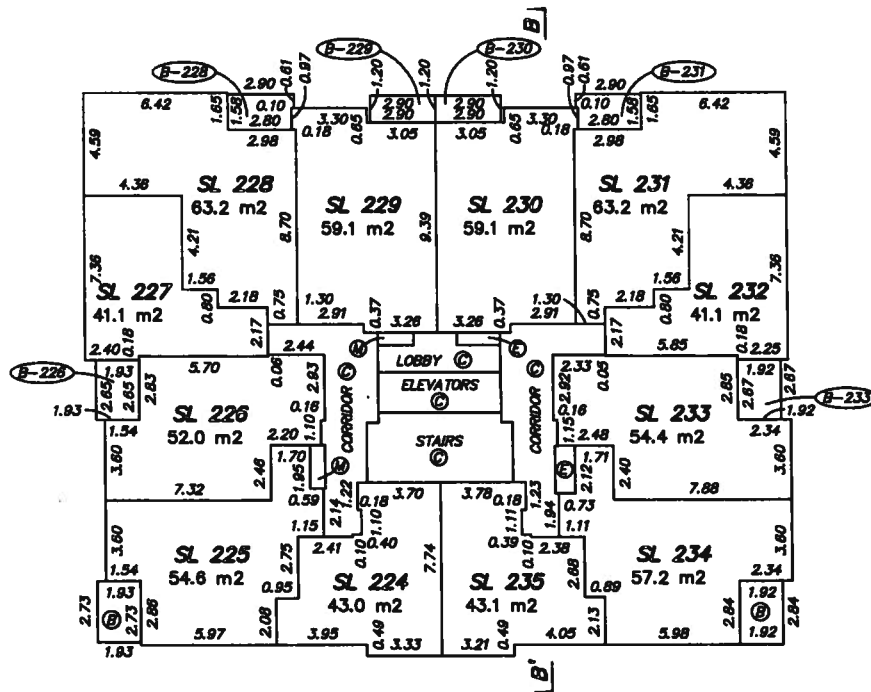

GARY SUNDWICK, BCLS
Date: SEPTEMBER 7, 2012
File: 3686-Strata-Final
Dwg: 3686-Strata

FLOOR PLAN
BUILDING B LEVEL 8

STRATA PLAN EPS984



SCALE 1:200 DISTANCES ARE IN METRES
THE INTENDED PLOT SCALE OF THIS PLAN IS 280 mm
IN WIDTH BY 432 mm IN HEIGHT (B SIZE) WHEN
PLOTTED AT A SCALE OF 1:200.

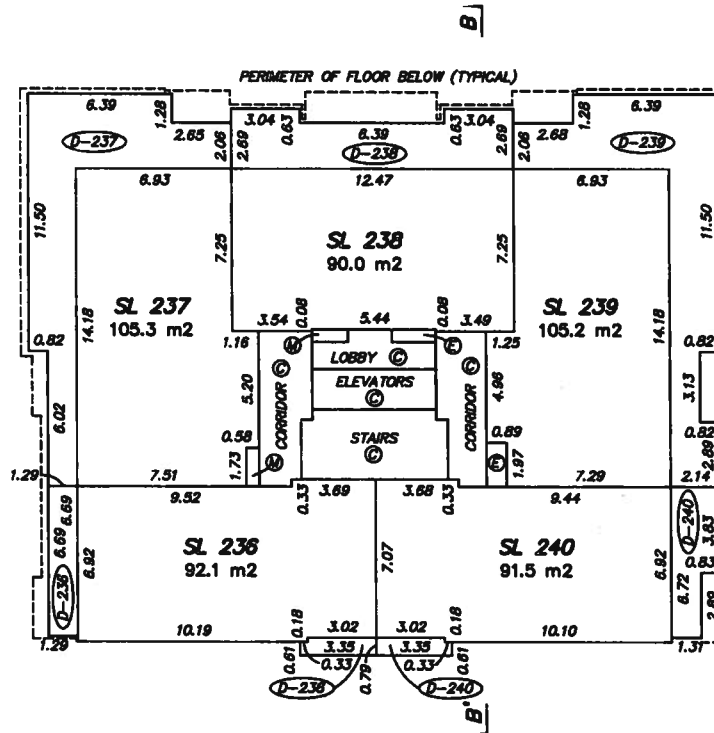

GARY SUNDVICK, BCLS
Date: SEPTEMBER 7, 2012
File: 3686\Strata-Final
Dwg: 3686-Strata

FLOOR PLAN BUILDING B LEVEL 9



SCALE 1:200 DISTANCES ARE IN METRES

THE INTENDED PLOT SCALE OF THIS PLAN IS 280 mm IN WIDTH BY 432 mm IN HEIGHT (B SIZE) WHEN PLOTTED AT A SCALE OF 1:200.



STRATA PLAN EPS984

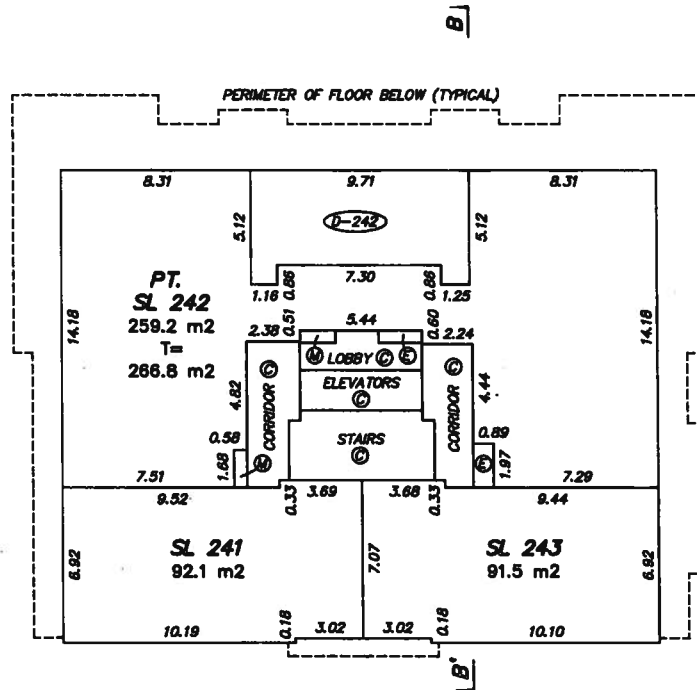

**BUTLER
SUNDVICK**
 GARY SUNDVICK, BCLS
 Date: SEPTEMBER 7, 2012
 File: 3688-Strata-Final
 Dwg: 3688-Strata

**FLOOR PLAN
BUILDING B LEVEL 10**



SCALE 1:200 DISTANCES ARE IN METRES
THE INTENDED PLOT SCALE OF THIS PLAN IS 280 mm
IN WIDTH BY 432 mm IN HEIGHT (B SIZE) WHEN
PLOTTED AT A SCALE OF 1:200.



STRATA PLAN EPS984

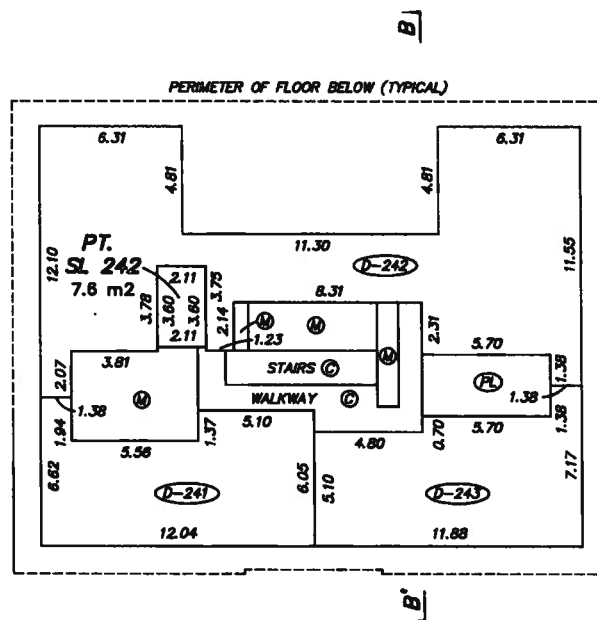

GARY SUNDVICK, BCLS
Date: SEPTEMBER 7, 2012
File: 3688\Strata-Final
Dwg: 3688-Strata

**FLOOR PLAN
BUILDING B ROOF**

STRATA PLAN EPS984



SCALE 1:200 DISTANCES ARE IN METRES

THE INTENDED PLOT SCALE OF THIS PLAN IS 280 mm IN WIDTH BY 432 mm IN HEIGHT (B SIZE) WHEN PLOTTED AT A SCALE OF 1:200.

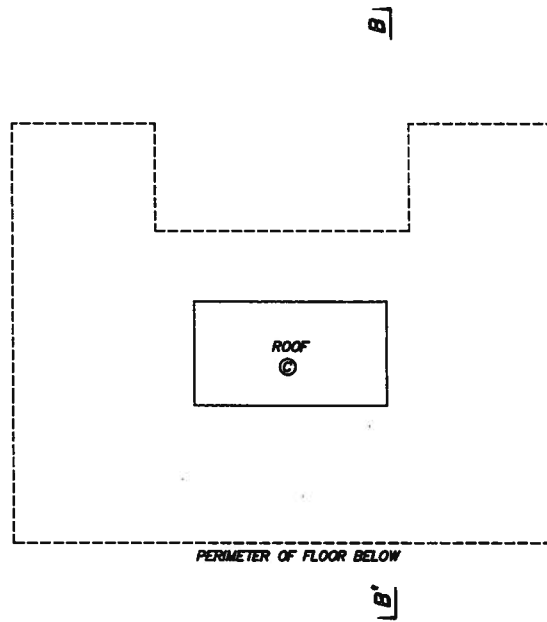

**BUTLER
SUNDVICK**
GARY SUNDVICK, BCLS
Date: SEPTEMBER 7, 2012
File: 3688\Strata-Final
Dwg: 3688-Strata

FLOOR PLAN BUILDING C LEVEL 3

STRATA PLAN EPS984

0 5 10 15

SCALE 1:200 DISTANCES ARE IN METRES
THE INTENDED PLOT SCALE OF THIS PLAN IS 280 mm
IN WIDTH BY 432 mm IN HEIGHT (B SIZE) WHEN
PLOTTED AT A SCALE OF 1:200.

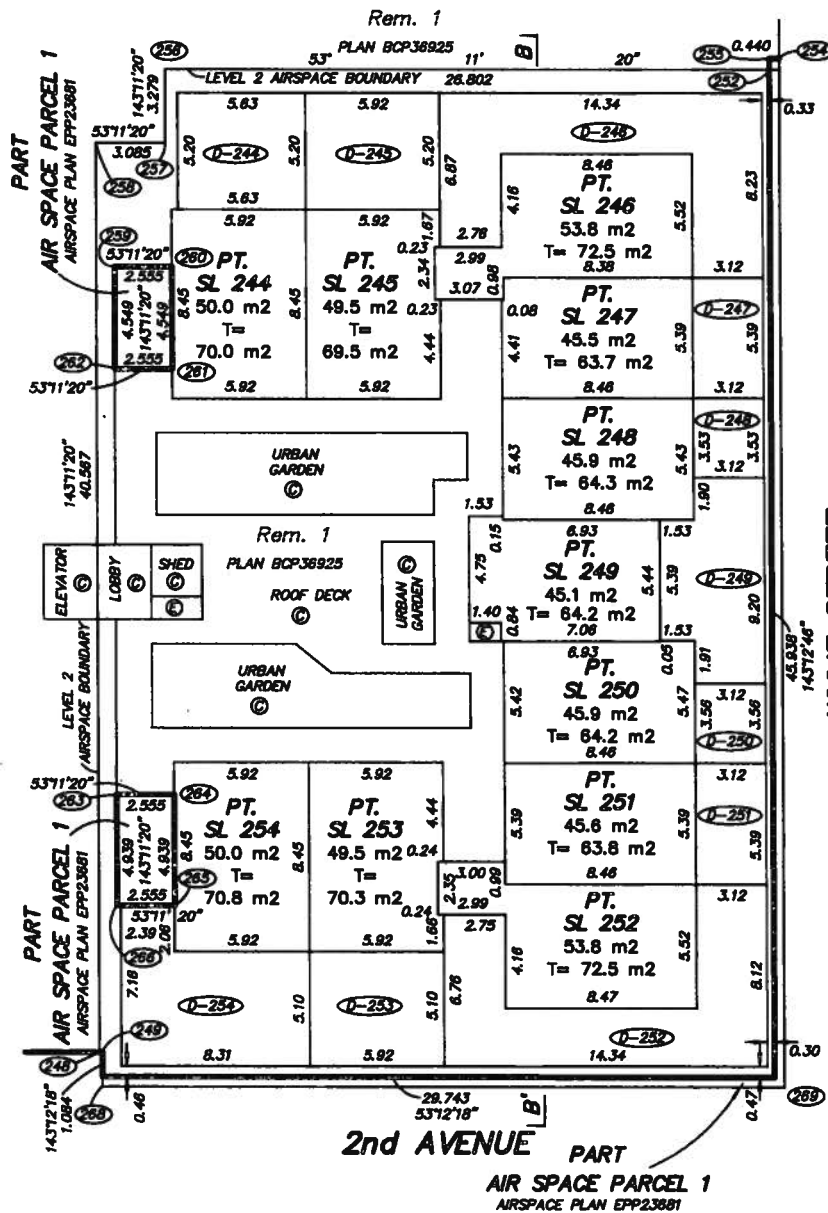

GARY SUNDVICK, BCLS
Date: SEPTEMBER 7, 2012
File: 3888-Strata-Final
Dwg: 3888-Strata

FLOOR PLAN BUILDING C LEVEL 4



SCALE 1:200 DISTANCES ARE IN METRES

THE INTENDED PLOT SCALE OF THIS PLAN IS 280 mm IN WIDTH BY 432 mm IN HEIGHT (B SIZE) WHEN PLOTTED AT A SCALE OF 1:200.



STRATA PLAN EPS984

PART
AIR SPACE PARCEL 1
AIRSPACE PLAN EPP23861

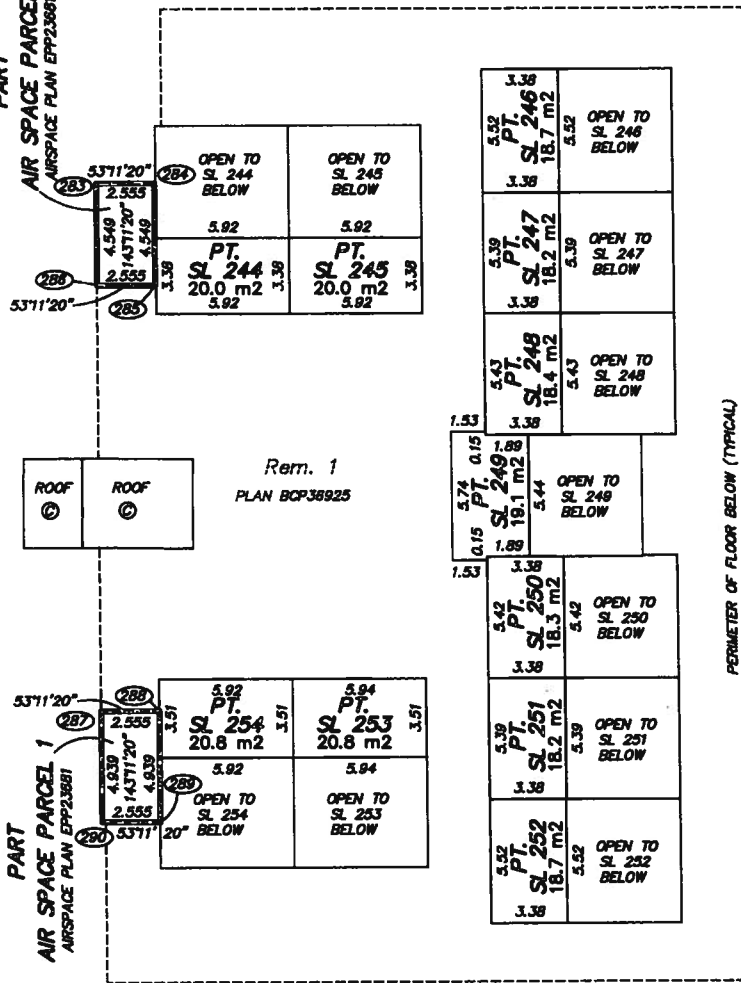

PART
AIR SPACE PARCEL 1
AIRSPACE PLAN EPP23861

BUTLER SANDWICK
 GARY SANDWICK, BCLS
 Date: SEPTEMBER 7, 2012
 File: 3688-Strata-Final
 Dwg: 3688-Strata

**FLOOR PLAN
BUILDING C ROOF**



SCALE 1:200 DISTANCES ARE IN METRES
THE INTENDED PLOT SCALE OF THIS PLAN IS 280 mm
IN WIDTH BY 432 mm IN HEIGHT (B SIZE) WHEN
PLOTTED AT A SCALE OF 1:200.



STRATA PLAN EPS984

B1

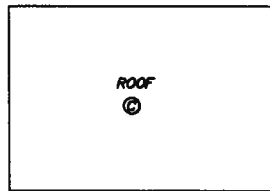

PERIMETER OF FLOOR BELOW

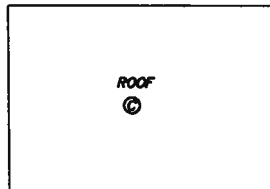
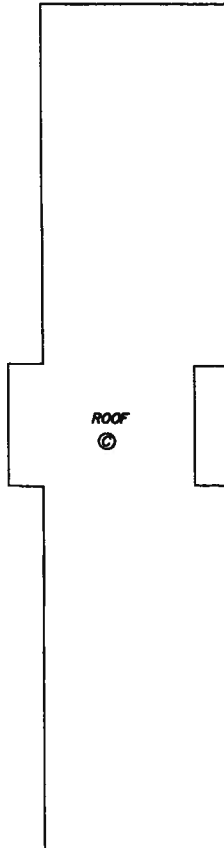

GARY SUNDWICK, BCLS
Date: SEPTEMBER 7, 2012
File: 3688\Strata-Final
Dwg: 3688-Strata

SECTION A-A'

STRATA PLAN EPS984



SCALE 1:200 DISTANCES ARE IN METRES

THE INTENDED PLOT SCALE OF THIS PLAN IS 280 mm IN WIDTH BY 432 mm IN HEIGHT (B SIZE) WHEN PLOTTED AT A SCALE OF 1:200.

SEE SHEET 54 FOR CONTINUATION

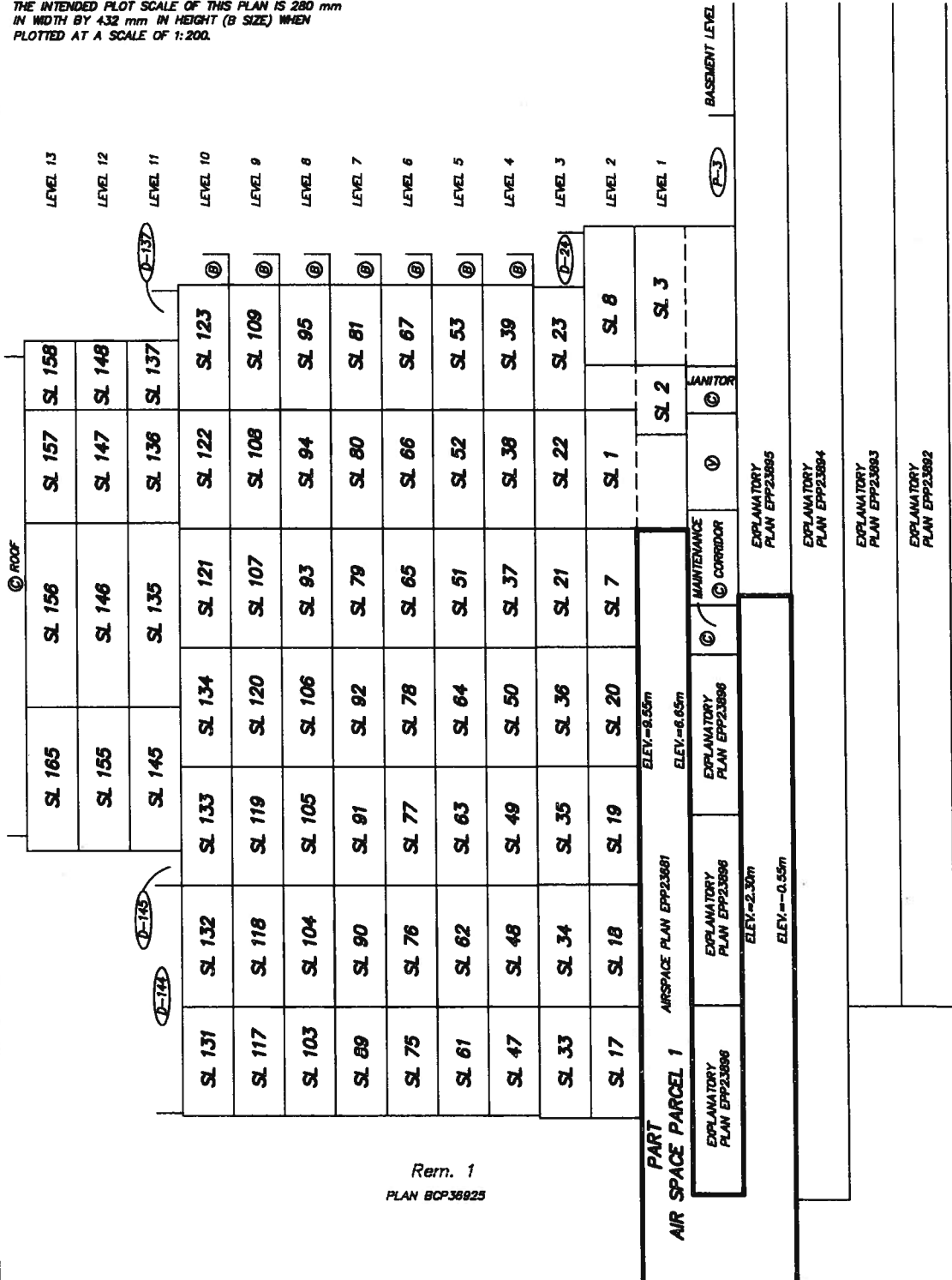

Rem. 1
PLAN BCP38825

PROPERTY LINE
2nd AVENUE

- PARKING LEVEL P1
- PARKING LEVEL P2
- PARKING LEVEL P3
- PARKING LEVEL P4

BUTLER SUNDVICK
 GARY SUNDVICK, BCLS
 Date: SEPTEMBER 7, 2012
 File: 3686-Strata-Final
 Dwg: 3686-Strata

SECTION A-A'

STRATA PLAN EPS984

0 5 10 15

SCALE 1:200 DISTANCES ARE IN METRES
THE INTENDED PLOT SCALE OF THIS PLAN IS 280 mm
IN WIDTH BY 432 mm IN HEIGHT (B SIZE) WHEN
PLOTTED AT A SCALE OF 1:200.

1st AVENUE

PARKING LEVEL P1
PARKING LEVEL P2
PARKING LEVEL P3
PARKING LEVEL P4

PROPERTY LINE

Rem. 1
PLAN BCP36825

BASEMENT LEVEL

EXPLANATORY PLAN EPP23895
EXPLANATORY PLAN EPP23884
EXPLANATORY PLAN EPP23883
EXPLANATORY PLAN EPP23882

SEE SHEET 53 FOR CONTINUATION



GARY SUNDVICK, BOLS
Date: SEPTEMBER 7, 2012
File: 3688-Strata-Final
Dwg: 3688-Strata

SECTION B-B'

STRATA PLAN EPS984



SCALE 1:200 DISTANCES ARE IN METRES
THE INTENDED PLOT SCALE OF THIS PLAN IS 280 mm IN WIDTH BY 432 mm IN HEIGHT (B SIZE) WHEN PLOTTED AT A SCALE OF 1:200.

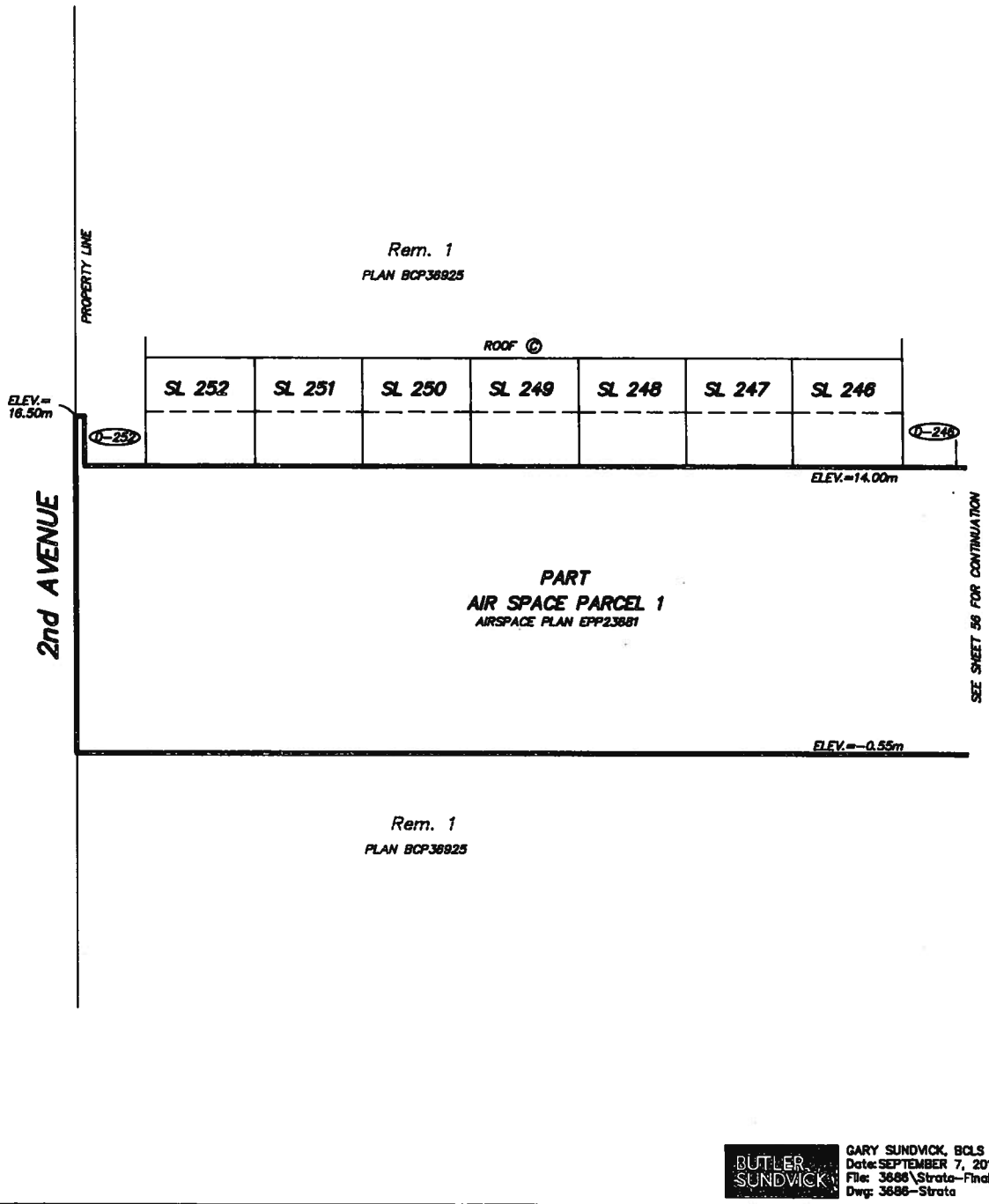

BUTLER SUNDVICK
 GARY SUNDVICK, BCLS
 Date: SEPTEMBER 7, 2012
 File: 3688\Strata-Final
 Dwg: 3688-Strata

SECTION B-B'

STRATA PLAN EPS984



SCALE 1:200 DISTANCES ARE IN METRES
 THE INTENDED PLOT SCALE OF THIS PLAN IS 280 mm IN WIDTH BY 432 mm IN HEIGHT (B SIZE) WHEN PLOTTED AT A SCALE OF 1:200.

Rem. 1
 PLAN BCP38925

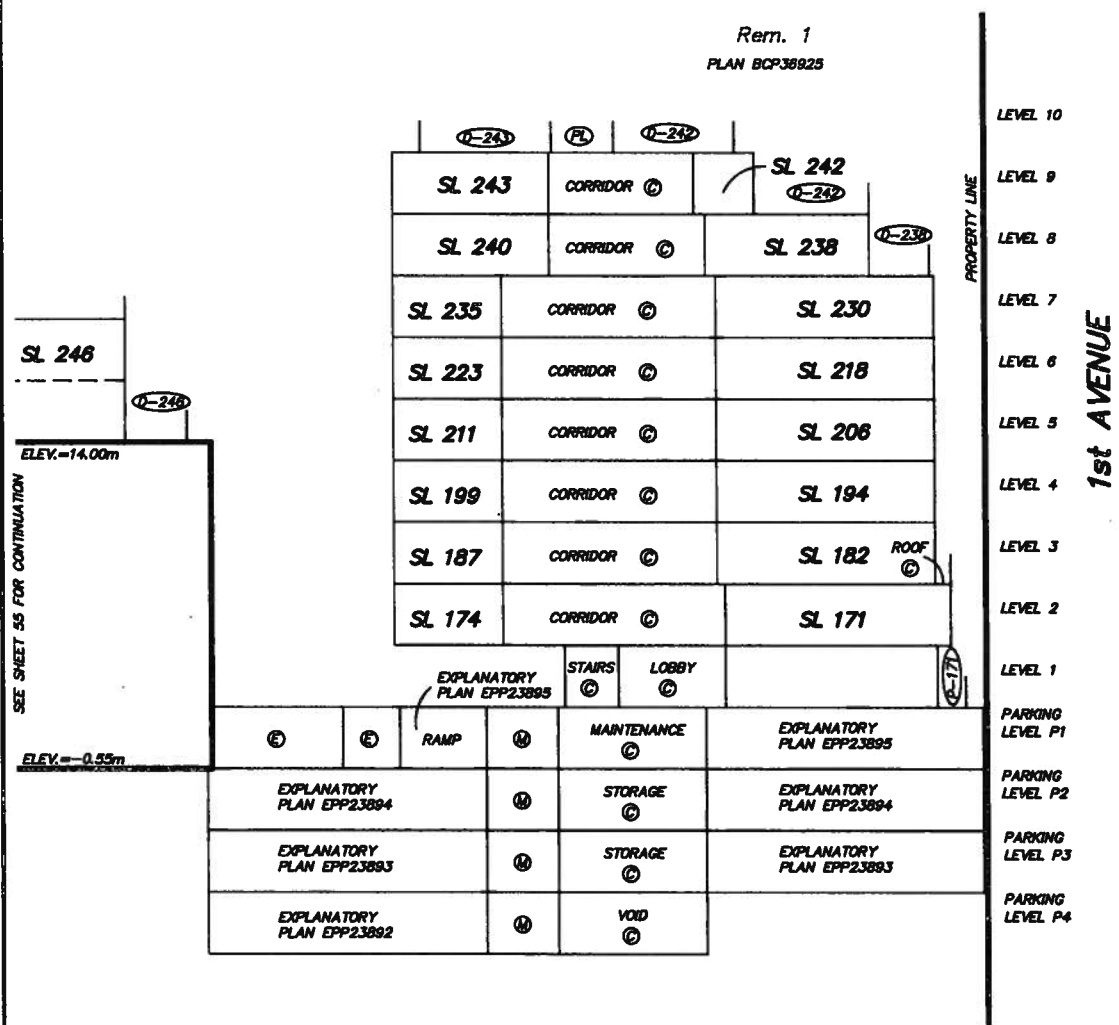

BUTLER SUNDVICK
 GARY SUNDVICK, BCLS
 Date: SEPTEMBER 7, 2012
 File: 3686-Strata-Final
 Dwg: 3686-Strata